

XGT Series

Programmable Logic Controller

Fast, Compact, Open Network Solution
Next Generation Technology



Automation Equipment

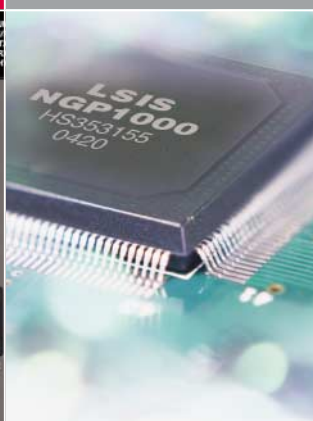

Contents

Features	Overview	4
CPU	Features	13
	CPU module	14
	I/O module	15
	Precaution when setting digital I/O module	24
System	XGR Configuration	26
	System configuration method	27
	System configuration	30
	Application	32
Network	General introduction	38
	RAPiEnet	40
	XGT Ethernet system	42
	XGT Industrial Optic Ring System	44
	XGT Ethernet switching hub	46
	Computer-Link	47
	Rnet system	48
	DeviceNet system	49
	Profibus system	52
	Computer-Link	54
	Profibus, DeviceNet)	56
	Smart I/O (Stand alone)	64
	SMART I/O (DeviceNet adapter)	65
	SMART I/O (Profibus-DP adapter)	66
	SMART I/O (Rnet adapter)	67
	Features	68
Special	Analog input module	71
	Analog output module	74
	High-speed counter module	76
	Positioning module [APM]	80
	Positioning module	82
	RTD input module	88
	Thermocouple module	89
Software	XG5000 programming	94
	XG-PD programming	104
	APM[Positioning module] Software Package	106
Product	Product list	107
	Dimensions	108
	XGR Dimensions	109

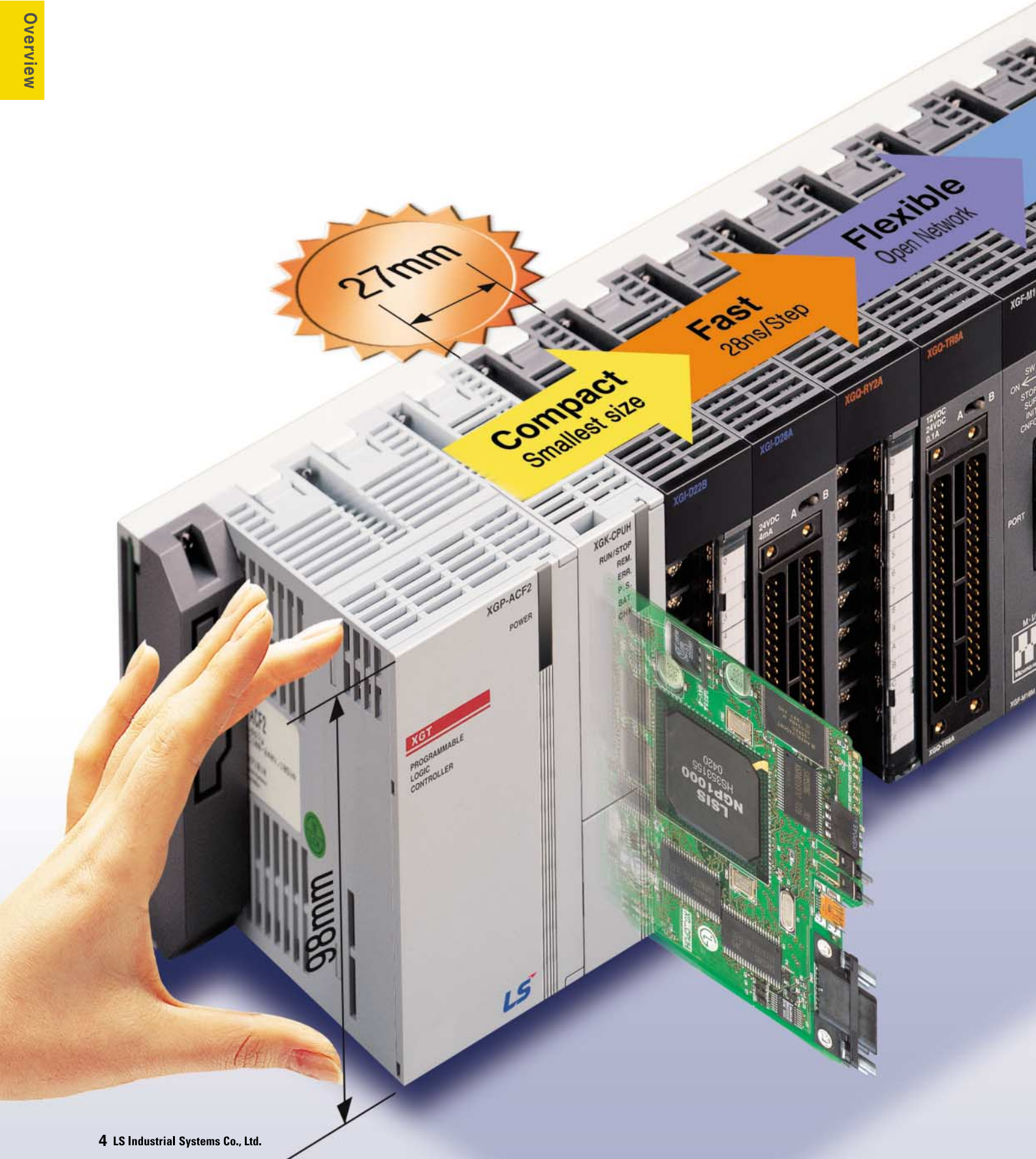

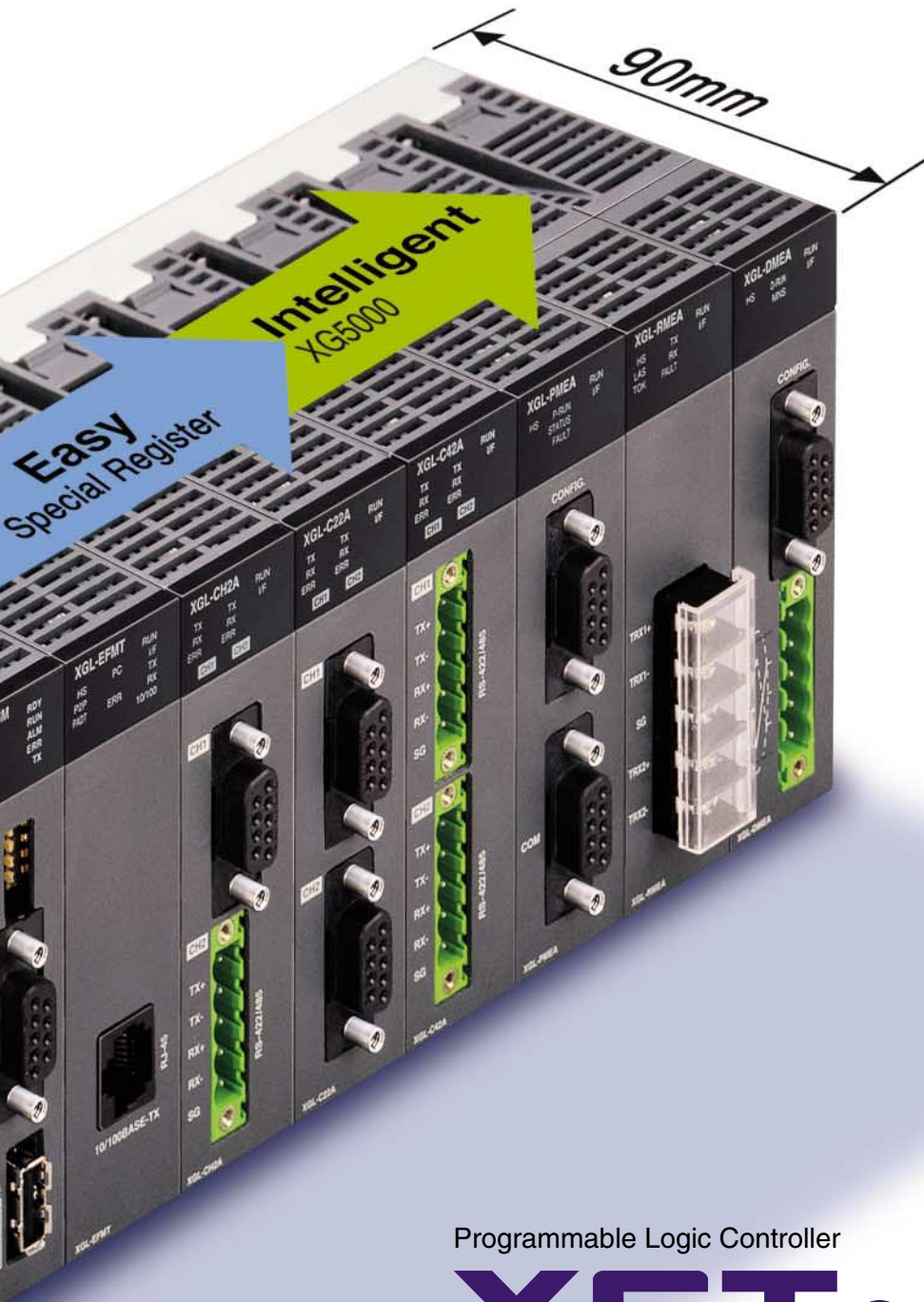

Overview

Programmable Logic Controller

XGT Series

neXt Generation Technology

XGT series is the next-generation solution with a new concept providing advanced engineering environment based on open network, fastest processing speed, compact size and user-friendly software.

XGT series is the Industrial Workhorse that can support various applications within the typical industrial plant.

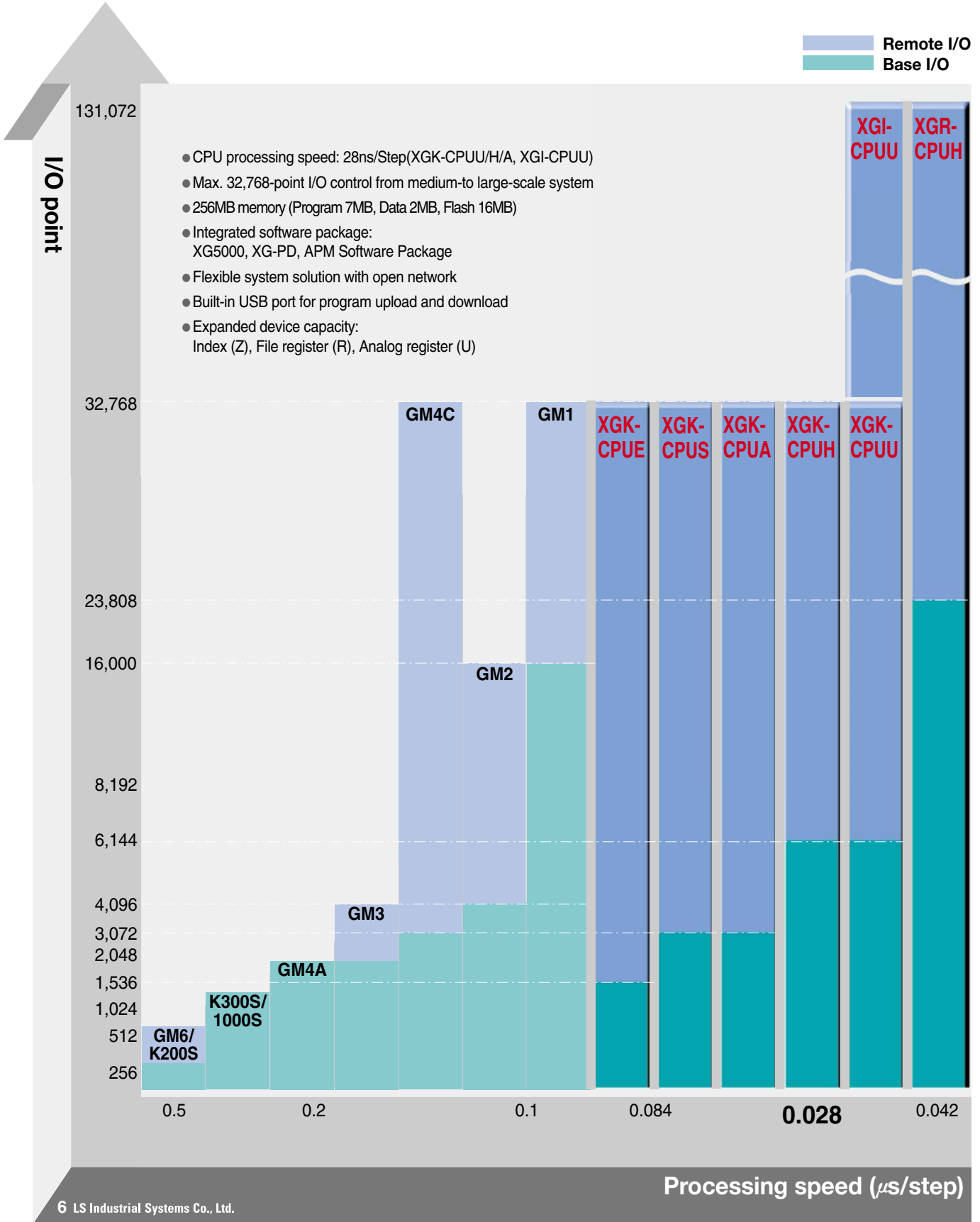

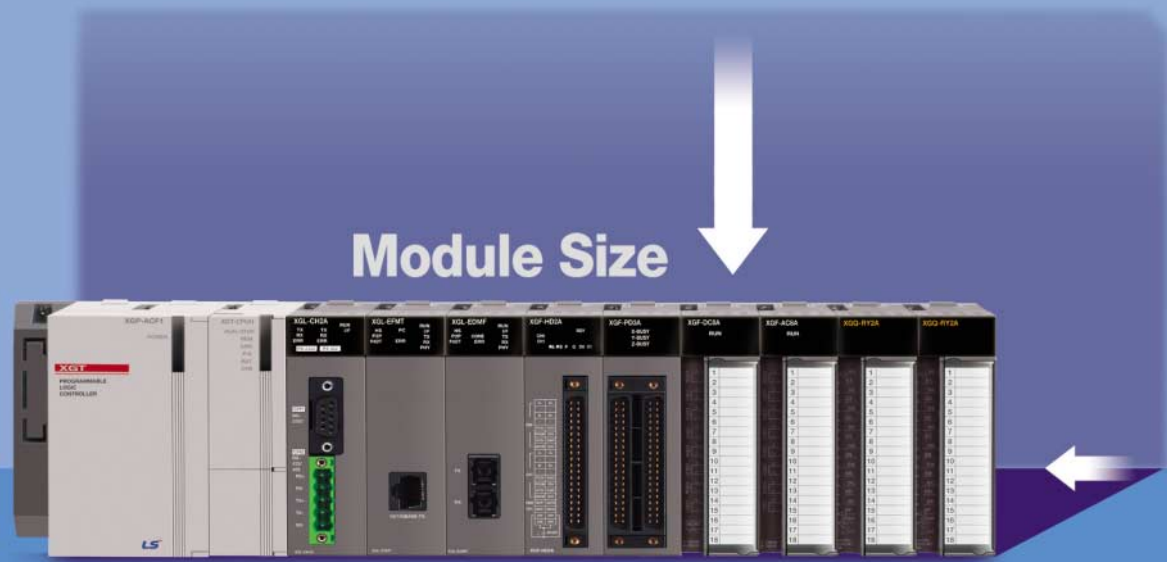

Size Innovation. . . **Compact**

The smallest size

The smallest size (Dimensions 27 × 98 × 90) achieves cost-efficiency and various applications.

Item	Power Supply	CPU	8-slot Base
Size (W × H × D)	55 × 98 × 90	27 × 98 × 90	318 × 98 × 15

Speed Innovation... **Fast**

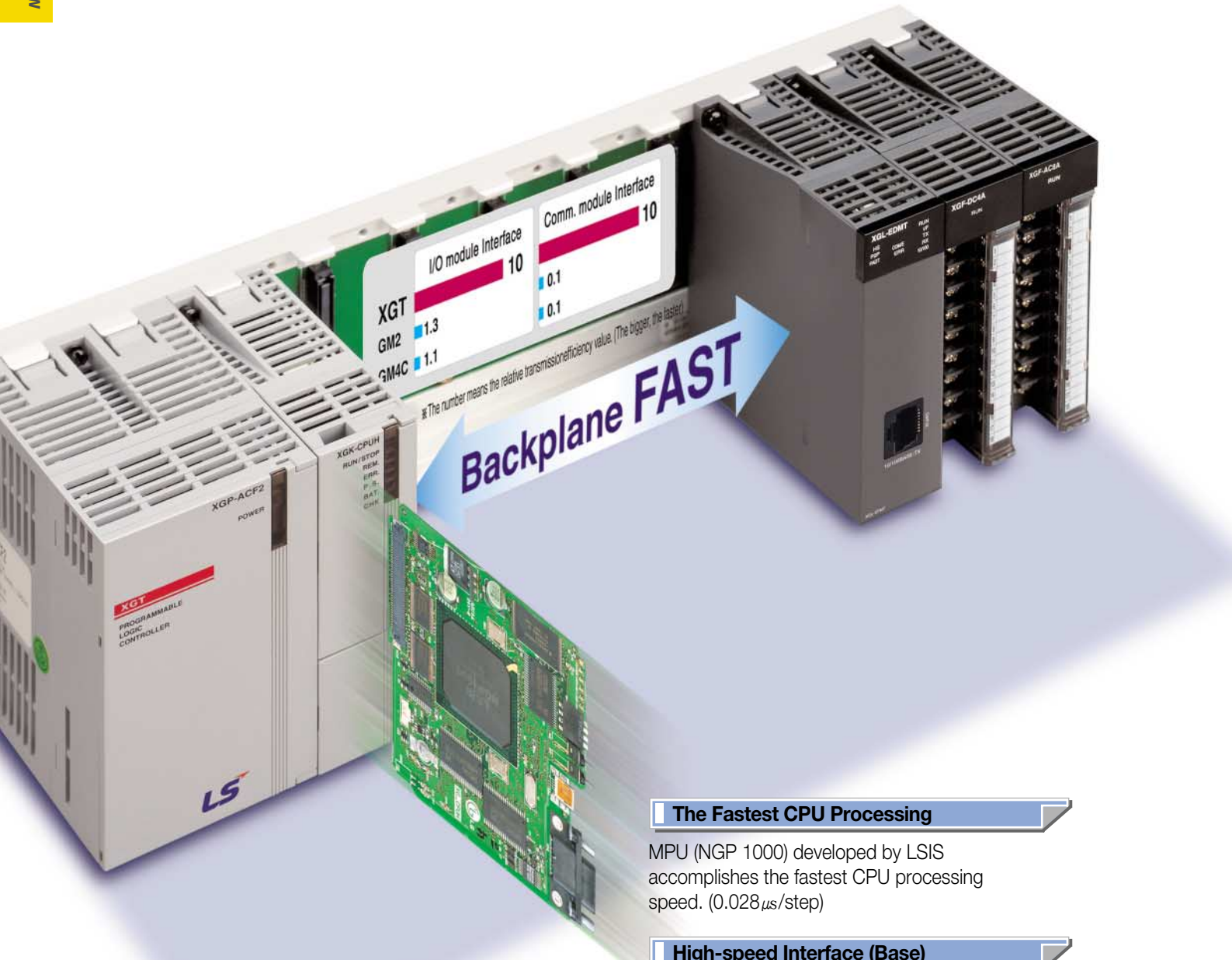

The Fastest CPU Processing

MPU (NGP 1000) developed by LSIS accomplishes the fastest CPU processing speed. (0.028 μ s/step)

High-speed Interface (Base)

Dedicated bus controller and High-speed transmission algorithm achieve high performance of internal interface.

Main Base	Expansion Base
20Mbyte/sec	5Mbyte/sec

Network Innovation... Flexible

System Integration of Open Network

XGT series support various communication solutions ranging from field control to information level with Fast Ethernet, Profibus-DP, DeviceNet, MODBUS

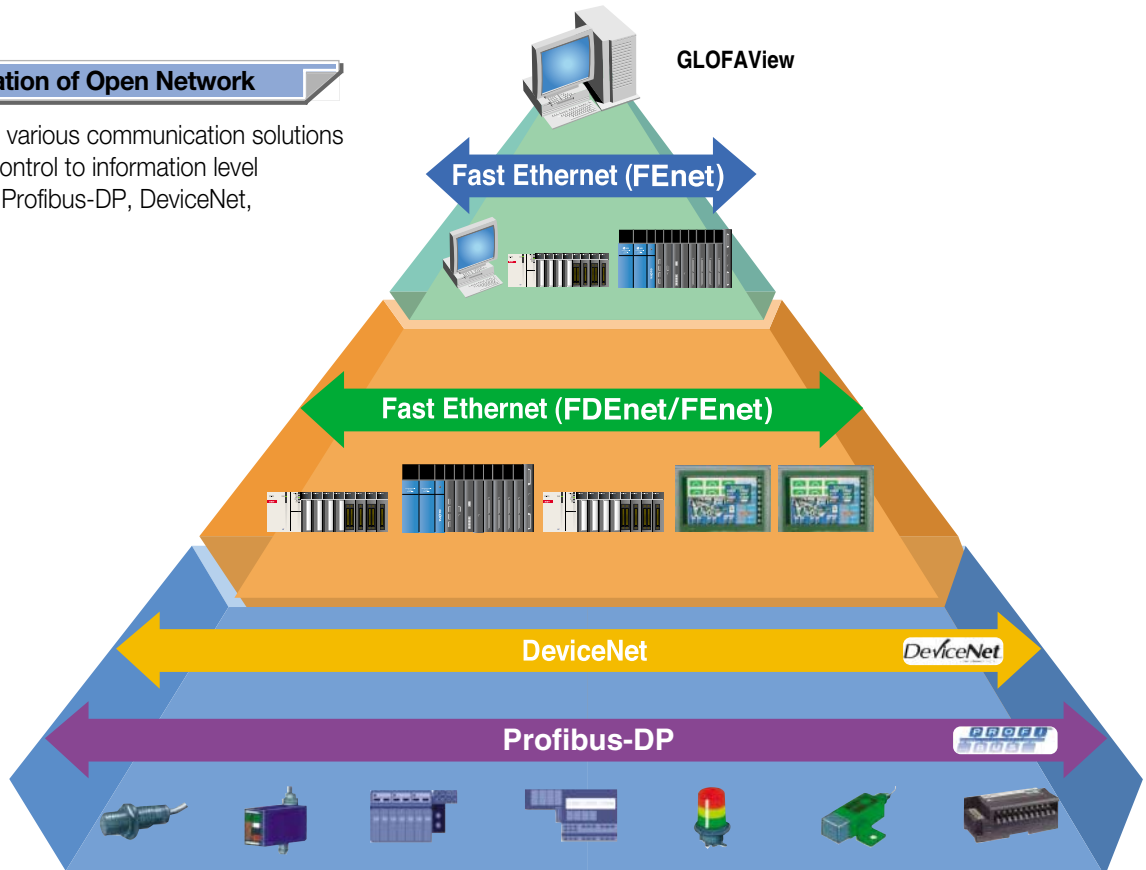

Item	Fast Ethernet		Cnet	Profibus-DP	DeviceNet
	FEnet	FDEnet			
Transmission speed	100 / 10Mbps		300 ~ 115,200bps	Max. 12Mbps	Max. 500Kbps
Transmission distance	100m (Node to Node, UTP/ STP) 2Km (Node to Node, Fiber Optic)		Max 500m (422 / 485)	Max. 1.2Km	Max 500m
Max. number of station	64 (HS link)		32	126	64
Service	HS link	●	-	●	●
	XG protocol	●	-	-	-
	General Protocol	● (MODBUS)	-	● (MODBUS)	-
	P2P	●	●	-	-
	XG5000 I/F	●	●	●	-
E-Mail	●	-	-	-	-
Configuration software	XG-PD			XG-PD & SyCon	
Number of installation	24 (HS link Service: 12, P2P Service: 8)				

Special Register

XGT series expand device memory and support advanced programming environment with Index register (Z), File register (U), and Analog register (U).

R File register
As a non-volatile memory type, data are secured even in times of blackout or CPU reset.

U Analog register
Assigning base, slot and memory buffer of an analog module to device, A/D conversion data can be accessed without analog commands.

Z Index register
Index register is used in the sequence program for array operation.

Example of Analog Register

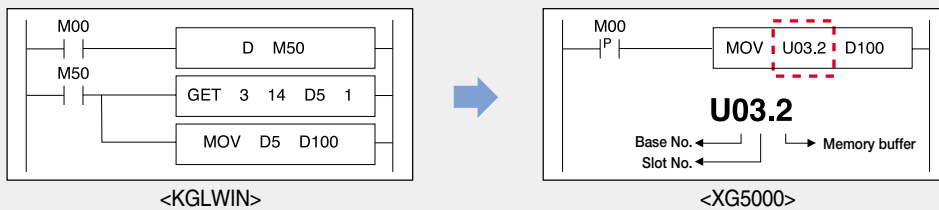

Analog Operation without Programming

Special module setup and operation is achieved by just parameter setting without additional program.

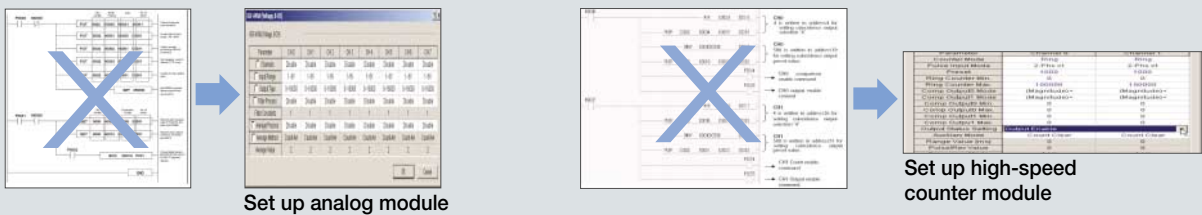

Program Modularization and Task Operation

Available to run multiful programs through medulization of scan programs based on functions and author, and to operate task programs triggered by specific conditions.

	Program type	Description	Number
Scan program	Scan	Executed in every scan	256-task
	Initialization task	Executed only one time when power turns on	1
	Time driven task	Executed with a constant time interval specified in parameter setting	32
Task program	Internal task	Executed by internal condition	32
	External interrupt task	Executed by external interrupt input	32

IEC standard language (XGI): LD, SFC, ST

Ladder Diagram

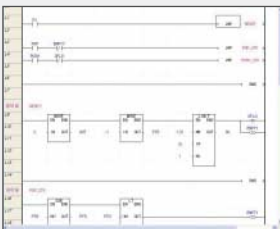

SFC

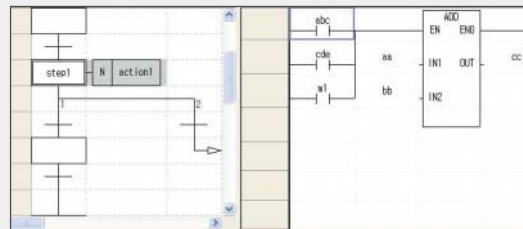

ST

```

19 X2 := (- 0 - SQRT(0))/(2.0*0) ;
20 END_IF ;
21
22
23 // CASE문 예제
24 TV := WORD_BCD_TO_INT(THUMBWHEEL);
25 TV_ERROR := 0;
26 CASE TV OF
27   1,0: DISPLAY := OVEN_TEMP;
28   2: DISPLAY := MOTOR_SPEED;
29   3: DISPLAY := GROSS - TARE;
30   4, 6..10: DISPLAY := ADD(TV, 4);
31 ELSE DISPLAY := 0;
32 TV_ERROR := 1;
33 END_CASE;
34 SHW100 := INT_TO_BCD_WORD(DISPLAY);
35
36 // FOR문 예제
37 SUM := 0;
38 FOR I := 1 TO 3 DO
39   FOR J := 1 TO 2 DO
40     IF FLAG THEN EXIT; END_IF;
41     SUM := SUM + J;
42   END_FOR;
43   SUM := SUM + I;
44 END_FOR;
45
46 X2 := -9.99979858e-002, 0 = 1.000000
47
48
49
50
51
52
53
54
55
56
57 SUM = 15,
58 I = 4,
59 J = 3,
60 FLAG = 0,
61 SUM = 15, J = 3,
62
63 SUM = 15, I = 4,
64
65
66
67
68
69
70
71
72
73
74
75
76
77
78
79
80
81
82
83
84
85
86
87
88
89
90
91
92
93
94
95
96
97
98
99
100
    
```

ST features

- High-level Language
- Fit for the complicate algorithm
- Various open source (Compatibility)
- Easy data processing
- Convenient text editor

User defined Function block (XGI)

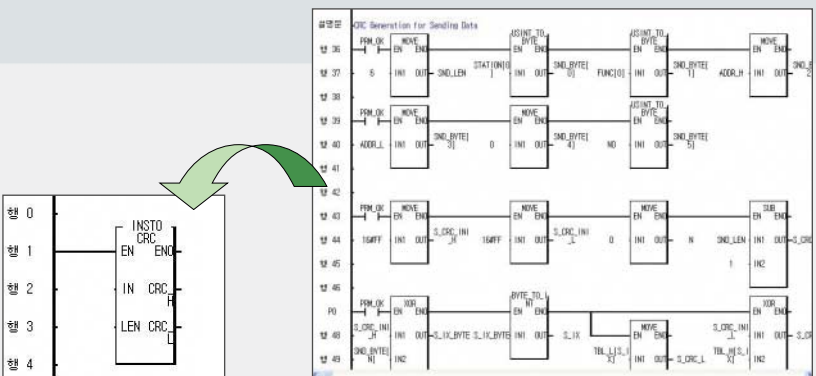

- Standardize the program using function or function block
- Register the standardized program as a library file and reuse the library for another project

Software Innovation. . . Intelligent

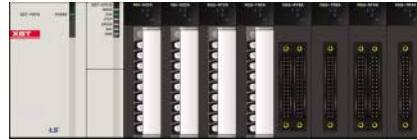

Integrated Programming & Engineering

XG5000 Software Package provides integrated engineering environment from basic programming to different special module setting as well as diagnosis. This package consists of XG5000 (PLC programming), XG-PD (Communication programming) and APM Software Package (Positioning programming).



XG5000

Program Editing & Engineering Software
Windows-based Easy Operation
Multi-PLC Multi-Programming Support
Various Monitoring & Diagnosis Functions



XG-PD

Comm. & Network Parameter Setting
Protocol Editing / Network Diagnosis
Frame Monitoring / Protocol Analysis



APM S/W package

Positioning Parameter Setting
Data Editing in EXCEL
Various Monitoring & Diagnosis
Tracking Function

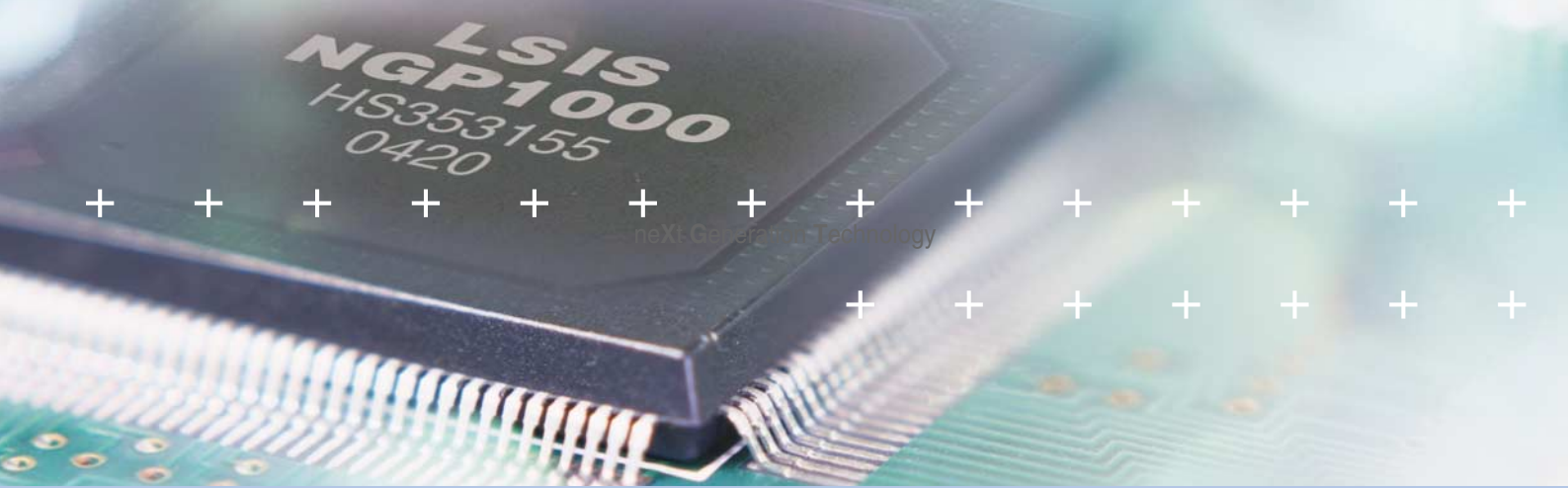

CPU

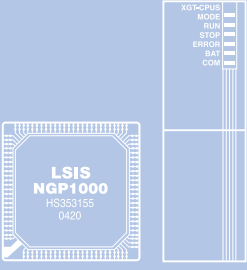

CPU & System configuration

XGT series contain variety of CPU types for customized solutions which support wide coverage from small/middle- to large size-system control.

IEC based CPU for high-speed and large scale application



XGI-CPUU (IEC Standard)

- Program capacity: 1Mbyte
- I/O points: 6,144
- I/O device point: 131,072 (Remote I/O)
- Processing speed: 28ns/step
- IEC 61131-3 standard programming
 - LD (ladder), SFC (Sequential Function Chart)
 - ST (Structured Text)
 - User defined FB (Function block)
- Powerful built-in PID and Process control
 - Max. 256 loops and variety of process functions
- Utilize the same I/O with XGK CPU
- Enable to convert from GLOGA PLC program to XGI program



XGI-CPUH (IEC Standard)

- Program capacity: 512Kbyte
- I/O points: 6,144
- I/O device point: 131,072 (Remote I/O)
- Processing speed: 28ns/step
- IEC 61131-3 standard programming
 - LD (ladder), SFC (Sequential Function Chart)
 - ST (Structured Text)
 - User defined FB (Function block)
- Powerful built-in PID and Process control
 - Max. 256 loops and variety of process functions
- Utilize the same I/O with XGK CPU
- Enable to convert from GLOGA PLC program to XGI program

Premium CPU for high-speed and large scale application



XGK-CPUU (Ultra capacity)

- Program capacity: 128K steps
- I/O points: 6,144
- I/O device point: 32,000 (Remote I/O)
- Processing speed: 28ns/step

XGK-CPUH (High performance)

- Program capacity: 64K steps
- I/O points: 6,144
- I/O device point: 32,000 (Remote I/O)
- Processing speed: 28ns/step



XGK-CPUA (Advanced)

- Program capacity: 32K step
- I/O point: 3,072
- I/O device point: 32,000 (Remote I/O)
- Processing speed: 28ns/step

General sequence controller PLC CPU



XGK-CPUS (Standard)

- Program capacity: 32K steps
- I/O points: 3,072
- I/O device point: 32,000 (Remote I/O)
- Processing speed: 84ns/step



XGK-CPUE (Economic)

- Program capacity: 16K step
- I/O point: 1,536
- I/O device point: 32,000 (Remote I/O)
- Processing speed: 84ns/step

CPU & System configuration / CPU module

System composition

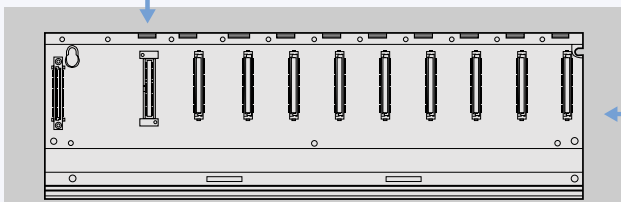
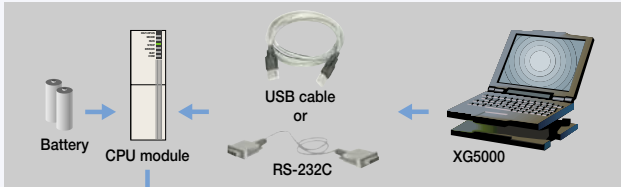

Main Base (XGB-M□□A)



Expansion cable (XGC-E□□□)

Item	Type	Description
Expansion cable	XGC-E041	Expansion cable 0.4m
	XGC-E061	Expansion cable 0.6m
	XGC-E121	Expansion cable 1.2m
	XGC-E301	Expansion cable 3.0m
	XGC-E501	Expansion cable 5.0m
	XGC-E102	Expansion cable 10m
Expansion terminator	XGT-TERA	Expansion terminator

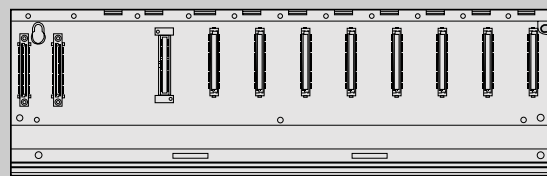

Expansion base (XGB-E□□A)

Item	Main base	Expansion base
4 Slot	XGB-M04A	XGB-E04A
6 Slot	XGB-M06A	XGB-E06A
8 Slot	XGB-M08A	XGB-E08A
12 Slot	XGB-M12A	XGB-E12A

• XG5000 Cable (RS-232C)

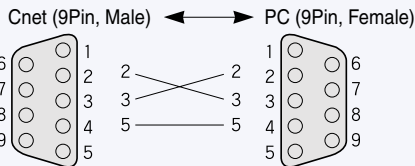

Power module (XGP-□□□□)

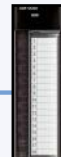

Input module (XGI-□□□□)

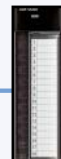

Output module (XGQ-□□□□)



Special module (XGF-□□□□)



Communication module (XGL-□□□□)

CPU module		
Type	I/O point	
XGI-CPUU/XGI-CPUH	6,144 (IEC type)	
XGK-CPUU/CPUH	6,144	
XGK-CPUA	3,072	
XGK-CPUS	3,072	
XGK-CPUE	1,536	

Item	Type	Description
USB cable	USB-901A	USB downloading cable
RS-232C cable	KIC-050A	RS-232C downloading cable

Power module			
AC	Free Voltage	XGP-ACF1	DC5V 3A DC24V 0.6A
		XGP-ACF2	DC5V 6A
DC	220V	XGP-AC23	DC5V 8.5A
		XGP-DC42	DC5V 6A

Item	Input module		
	AC110V	AC220V	DC24V
8 points	-	XGI-A21A	XGI-D21A
16 points	XGI-A12A	-	XGI-D22A
	-	-	XGI-D22B
32 points	-	-	XGI-D24A
	-	-	XGI-D24B
64 points	-	-	XGI-D28A
	-	-	XGI-D28B

Item	Output module		
	Relay	Triac	Transistor
8 points	XGQ-RY1A	-	-
16 points	XGQ-RY2A	XGQ-SS2A	XGQ-TR2A
	XGQ-RY2B	-	XGQ-TR2B
32 points	-	-	XGQ-TR4A
	-	-	XGQ-TR4B
64 points	-	-	XGQ-TR8A
	-	-	XGQ-TR8B

Item	Input/Output mixed module	
	16-point DC input	16-point TR output

Special module		
Analog input	XGF-AV8A	Voltage input type, 8Ch
	XGF-AC8A	Current input type, 8Ch
	XGF-AD8A	Voltage/ Current input, 8Ch
	XGF-AD4S	Voltage/ Current input, 4Ch (Isolated)
Analog output	XGF-AD16A	Voltage/ Current input, 16Ch
	XGF-DV4A	Voltage output type, 4Ch
	XGF-DC4A	Current output type, 4Ch
	XGF-DV8A	Voltage output type, 8Ch
High-speed counter	XGF-DC8A	Current output type, 8Ch
	XGF-DV4S	Voltage output, 4Ch (Isolated)
	XGF-DC4S	Current output, 4Ch (Isolated)
	XGF-HO2A	Pulse (OC) input type, 2Ch
Positioning	XGF-HD2A	Pulse (LD) input type, 2Ch
	XGF-PO3A	Pulse (OC) output type, 3 axes
	XGF-PO2A	Pulse (OC) output type, 2 axes
	XGF-PO1A	Pulse (OC) output type, 1 axis
Temperature control	XGF-PD3A	Pulse (LD) output type, 3 axes
	XGF-PD2A	Pulse (LD) output type, 2 axes
	XGF-PD1A	Pulse (LD) output type, 1 axis
	XGF-TC4S	Thermocouple input, 4Ch
Temperature controller	XGF-RD4A	RTD input, 4Ch
	XGF-RD4S	RTD input, 4Ch (Insulated)
Temperature controller	XGF-TC4UD	Temperature controller, 4 loops, Universal input

Communication module		
RAPIEnet	XGL-EIMT	RAPIEnet Twisted fair 2Ch
	XGL-EIMH	RAPIEnet Fiber optic/Twisted fair 1Ch
	XGL-EIMF	RAPIEnet Fiber optic 2Ch
	XOL-EIMT	RAPIEnet Twisted fair 2Ch For PC
	XOI-EIMF	RAPIEnet Fiber optic 2Ch For PC
Cnet	XGL-CH2A	RS-232C/RS-422
	XGL-C22A	RS-232C, 2Ch
	XGL-C42A	RS-422, 2Ch
Ethernet (Open)	XGL-EFMF	Fiber optic, Master, SC type
	XGL-EFMT	Twisted pair, Master, RJ-45
	XGL-ESHF	Fast Ethernet, Industrial Ring module
	XGL-EHST	Fast Ethernet, Switching hub
Ethernet (Dedicated)	XGL-EDMF	Fiber optic, Master, SC type
	XGL-EDMT	Twisted pair, Master, RJ-45
Rnet	XGL-RMEA	Rnet, Master, TP
DeviceNet	XGL-DMEA	DeviceNet, Master
Profibus-DP	XGL-PMEA	Profibus-DP, Master

Specifications

Item	Description	Standard			
Ambient temperature	0 ~ 55 °C				
Storage temperature	-25 ~ +70 °C				
Ambient humidity	5 ~ 95%RH (Non-condensing)				
Storage humidity	5 ~ 95%RH (Non-condensing)				
Vibration resistance	Occasional vibration		10 times each direction (X, Y and Z)	IEC 61131-2	
	Frequency	Acceleration			Pulse width
	10 ≤ f < 57Hz	-			0.075mm
	57 ≤ f < 150Hz	9.8m/s ² (1G)			-
	Continuous vibration				
	Frequency	Acceleration			Pulse width
10 ≤ f < 57Hz	-	0.035mm			
57 ≤ f < 150Hz	4.9m/s ² (0.5G)	-			
Shock resistance	· Peak acceleration: 147 m/s ² (15G) · Duration: 11ms · Half-sine, 3 times each direction per each axis		IEC 61131-2		
Noise resistance	Square wave impulse noise	± 1,500p-p		LSIS Standard	
	Electrostatic discharge	± 4KV		IEC 61131-2, IEC 1000-1-2	
	Radiated electromagnetic field noise	27~500MHz, 10V/m		IEC 61131-2, IEC 1000-1-3	
	Fast transient/ Burst noise	0.25KV		IEC 61131-2, IEC 1000-1-4	
Operating Ambience	Free from corrosive gases and excessive dust				
Altitude	Up to 2,000m				
Pollution degree	Less than equal to 2				
Cooling	Air-cooling				

* Pollution degree 2 is nonconductive pollution of the sort where occasionally a temporary conductivity caused by condensation must be expected.

Item	Description					Remarks	
	XGK-CPUE	XGK-CPUS	XGK-CPUA	XGK-CPUH	XGK-CPUU		
Operation method	Cyclic execution of stored program, Time-driven interrupt, Process-driven interrupt						
I/O control method	Batch processing by scan synchronization (Refresh), Direct input/output by instructions						
Program language	Ladder diagram, Instruction list						
Number of instructions	Basic					42	
	Application					600	
Processing speed	Sequence instruction (μs)		0.028μs/step				
	Application instruction (μs)		0.084μs/step				
	Floating instruction (μs)		±: 0.602μs (S), 1.078μs (D) ×: 1.106μs (S), 2.384μs (D) ÷: 1.134μs (S), 2.66μs (D)				
Program capacity	16K Steps	32K Steps	32K Steps	64K Steps	128K Step		
I/O points (available to install)	With 16-point I/O		384	768	768	1536	
	With 32-point I/O		768	1536	1536	3072	
	With 64-point I/O		1536	3072	3072	6144	
Data area	P	P0000 ~ P2047F (32768 points)				I/O relay	
	M	M0000 ~ M2047F (32768 points)				Auxiliary relay	
	K	K000 ~ K2047F (32768 points)				Special relay	
	L	L000 ~ L11263F (32768 points)				Link relay	
	F	F000 ~ F2047F (32768 points)				Keep relay	
	T	100ms: T0000 - T0999				Timer (Adjustable)	
		10ms: T1000 - T1499					
		1ms: T1500 - T1999					
	C	0.1ms: T2000 - T2047				Counter	
		C0000 ~ C2047					
S	S00.00 ~ S127.99				Step controller		
D	D0000 ~ D19999		D0000 ~ D32767			Register	
U	U0.0-U1F.31	U0.0-U3F.31	U0.0-U3F.31	U0.0-U7F.31		Analog resistor	
Z	128points				Index register		
File register	RAM: 1 block		RAM: 2 blocks			1 block: R0 ~ R32767	
	Flash: 2M byte, 32 blocks						
Program type	Total program					256	
	Initialization					1 (LINT)	
	Time-driven					32	
	External					32	
Operation mode	Internal					32	
	RUN, STOP, DEBUG						
Self-diagnosis	Execution, Delay, Memory error, I/O error, Battery error, Power error						
Programming port	RS-232C (1Ch), USB (1Ch)					MODBUS slave	
Data retention at power failure	Set "retain" at data declaration						
Max. expansion stage	2	4	4	8			
Current consumption (mA)	960		960				
Weight (Kg)	0.12		0.12				

Specifications

Item		XGI-CPUU	XGI-CPUH	Remarks	
Operation system		Reiterative operation, fixed cycle operation, constant scan			
I/O Control system		Scan synchronous batch processing system(refresh system), direct system by command			
Program language		Ladder Diagram, SFC (Sequential Function Chart), ST (Structured Text), IL (Read only)			
No. of commands	Operator	18			
	Basic function	136 types + real number operation function			
	Basic function block	43			
	Dedicated function block	Dedicated function blocks by special function modules, communication dedicated function block(P2P)			
Operation processing speed (basic command)	Basic	0.028 μ s/step			
	MOVE	0.084 μ s/step			
	Real number operation	\pm :0.392 μ s(S), 0.924 μ s(D) \times :0.896 μ s(S), 2.240 μ s(D) \div :0.924 μ s(S), 2.254 μ s(D)		S: Single real number D: Double real number	
Program memory capacity		1Mbyte	512Kbyte	Including upload program	
I/O points(installable)		6,144points			
Max. I/O memory contact)		131,072points			
Data memory	Symbolic variable area(A)	512KB (max. 256KB retain settable)			
	I variable(I)	16Kbyte			
	Q variable(Q)	16Kbyte			
	Direct variable	M	256KB (max. 128KB retain settable)		64kbyte per block
		R	64Kbyte * 2block		
		W	128Kbyte		System flag
	Flag variable	F	4Kbyte		PID flag
		K	16Kbyte		High speed link flag
		L	22Kbyte		
U		8Kbyte			
Flash area		2Mbyte, 32block		Controllable by R device	
Timer		No point limit Time range: 0.001~ 4,294,967.295 second(1,193 hours)		20 bytes of symbolic variable area per point	
Counter		No point limit Coefficient range : 64 bit expression		8 bytes of symbolic variable area per point	
Program structure	Total no. of programs	256			
	Initialization task	1			
	Fixed cycle task	32			
	Internal device task	32			
Operation mode		RUN, STOP, DEBUG			
Restart mode		Cold, Warm			
Self diagnosis		Operation delay monitoring, memory fault, I/O fault, battery fault, power fault and etc			
Built-in function		Modbus slave, PID			
Download port		RS-232C(1CH), USB(1CH)			
Data protection in case of power failure		Retain area setting by basic parameters			
Max. base extension		8		Total length :15 m	
Current consumption(mA)		960			
Weight (kg)		0.12			

XGK system configuration

Item	XGK-CPUE	XGK-CPUS	XGK-CPUA	XGK-CPUH	XGK-CPUU																																							
Max. expansion stage	1 stages	3 stages	3 stages	7 stages	7 stages																																							
Max. installation of module	24 modules	48 modules	48 modules	96 modules	96 modules																																							
Max. number of I/O point	1,536	3,072	3,072	6,144	6,144																																							
Max. expansion distance	15m																																											
Assignment of I/O number (Fixed)	<ul style="list-style-type: none"> 64 points are assigned to each slot of base regardless of installation of module. I/O numbers equivalent to 12 slots are assigned to a base. The starting number of base '0' is P0000. Refer to the following figure regarding the I/O number assignment of 12 slots <table border="1"> <thead> <tr> <th>Slot number:</th> <th>0</th> <th>1</th> <th>2</th> <th>3</th> <th>4</th> <th>5</th> <th>6</th> <th>7</th> <th>8</th> <th>9</th> <th>10</th> <th>11</th> </tr> </thead> <tbody> <tr> <td>Power</td> <td>CPU</td> <td>64 points</td> <td>64 points</td> <td>64 points</td> <td>64 points</td> <td>64 points</td> <td>64 points</td> <td>64 points</td> <td>64 points</td> <td>64 points</td> <td>64 points</td> <td>64 points</td> </tr> <tr> <td></td> <td></td> <td>P0 - P3F</td> <td>P40 - P7F</td> <td>P80 - P11F</td> <td>P120 - P15F</td> <td>P160 - P19F</td> <td>P200 - P23F</td> <td>P240 - P27F</td> <td>P280 - P31F</td> <td>P320 - P35F</td> <td>P360 - P39F</td> <td>P400 - P47F</td> </tr> </tbody> </table>					Slot number:	0	1	2	3	4	5	6	7	8	9	10	11	Power	CPU	64 points	64 points	64 points	64 points	64 points	64 points	64 points	64 points	64 points	64 points	64 points			P0 - P3F	P40 - P7F	P80 - P11F	P120 - P15F	P160 - P19F	P200 - P23F	P240 - P27F	P280 - P31F	P320 - P35F	P360 - P39F	P400 - P47F
Slot number:	0	1	2	3	4	5	6	7	8	9	10	11																																
Power	CPU	64 points	64 points	64 points	64 points	64 points	64 points	64 points	64 points	64 points	64 points	64 points																																
		P0 - P3F	P40 - P7F	P80 - P11F	P120 - P15F	P160 - P19F	P200 - P23F	P240 - P27F	P280 - P31F	P320 - P35F	P360 - P39F	P400 - P47F																																
I/O assignment (Variable)	<ul style="list-style-type: none"> I/O point is assigned automatically according to the installed module. I/O parameter is used to install modules. The starting number of base '0' is P0000. 16 points are assigned automatically to the slot of special or communication module Refer to the following figure regarding the I/O number assignment of 12 slots. <table border="1"> <thead> <tr> <th>Slot number:</th> <th>0</th> <th>1</th> <th>2</th> <th>3</th> <th>4</th> <th>5</th> <th>6</th> <th>7</th> <th>8</th> <th>9</th> <th>10</th> <th>11</th> </tr> </thead> <tbody> <tr> <td>Power</td> <td>CPU</td> <td>16 points</td> <td>16 points</td> <td>32 points</td> <td>64 points</td> <td>16 points</td> <td>32 points</td> <td>32 points</td> <td>64 points</td> <td>32 points</td> <td>16 points</td> <td>32 points</td> </tr> <tr> <td></td> <td></td> <td>P00 - P0F</td> <td>P10 - P1F</td> <td>P20 - P3F</td> <td>P40 - P7F</td> <td>P80 - P8F</td> <td>P90 - P10F</td> <td>P110 - P12F</td> <td>P130 - P16F</td> <td>P170 - P18F</td> <td>P190 - P19F</td> <td>P200 - P23F</td> </tr> </tbody> </table>					Slot number:	0	1	2	3	4	5	6	7	8	9	10	11	Power	CPU	16 points	16 points	32 points	64 points	16 points	32 points	32 points	64 points	32 points	16 points	32 points			P00 - P0F	P10 - P1F	P20 - P3F	P40 - P7F	P80 - P8F	P90 - P10F	P110 - P12F	P130 - P16F	P170 - P18F	P190 - P19F	P200 - P23F
Slot number:	0	1	2	3	4	5	6	7	8	9	10	11																																
Power	CPU	16 points	16 points	32 points	64 points	16 points	32 points	32 points	64 points	32 points	16 points	32 points																																
		P00 - P0F	P10 - P1F	P20 - P3F	P40 - P7F	P80 - P8F	P90 - P10F	P110 - P12F	P130 - P16F	P170 - P18F	P190 - P19F	P200 - P23F																																

The standard I/O number assignment is 64 points. (Fixed)

XGI system configuration

Item	XGI-CPUH	XGI-CPUU																																							
Max. expansion stage	7																																								
Max. installation of module	96																																								
Max. number of I/O point	1,536 (for 16point I/O module) 3,072 (for 32point I/O module) 6,144 (for 64point I/O module)																																								
Max. expansion distance	15m																																								
I/O assignment	<ul style="list-style-type: none"> 64 points are assigned to each slot of base regardless of installation of module. No limit in installation of special module Special module is controlled by function block and the memory assignment is done automatically Refer to the following figure regarding the I/O assignment of 12 slots <table border="1"> <thead> <tr> <th>Slot number:</th> <th>0</th> <th>1</th> <th>2</th> <th>3</th> <th>4</th> <th>5</th> <th>6</th> <th>7</th> <th>8</th> <th>9</th> <th>10</th> <th>11</th> </tr> </thead> <tbody> <tr> <td>Power</td> <td>CPU</td> <td>16 points</td> <td>16 points</td> <td>32 points</td> <td>64 points</td> <td>16 points</td> <td>32 points</td> <td>32 points</td> <td>64 points</td> <td>32 points</td> <td>16 points</td> <td>32 points</td> </tr> <tr> <td></td> <td></td> <td></td> <td></td> <td></td> <td></td> <td></td> <td></td> <td></td> <td></td> <td></td> <td></td> <td></td> </tr> </tbody> </table> <p> $\%I \times 0.8.0\text{--}31$ $\%Q \times 0.9.0\text{--}15$ $\%Q \times 0.10.0\text{--}31$ $\%Q \times 0.11.0\text{--}31$ </p>		Slot number:	0	1	2	3	4	5	6	7	8	9	10	11	Power	CPU	16 points	16 points	32 points	64 points	16 points	32 points	32 points	64 points	32 points	16 points	32 points													
Slot number:	0	1	2	3	4	5	6	7	8	9	10	11																													
Power	CPU	16 points	16 points	32 points	64 points	16 points	32 points	32 points	64 points	32 points	16 points	32 points																													

Expansion system composition

1. The following figure is the example of expansion system with the fixed I/O point type of XGK-CPUH.
2. The address of I/O point is adjustable by XG5000 parameter.

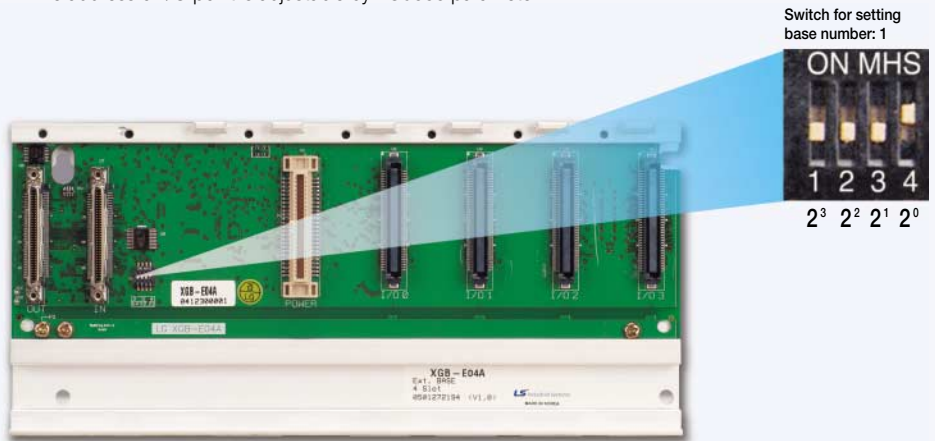

The lowest expansion base should be connected to the upper stage with expansion terminator(XGT-TERA).

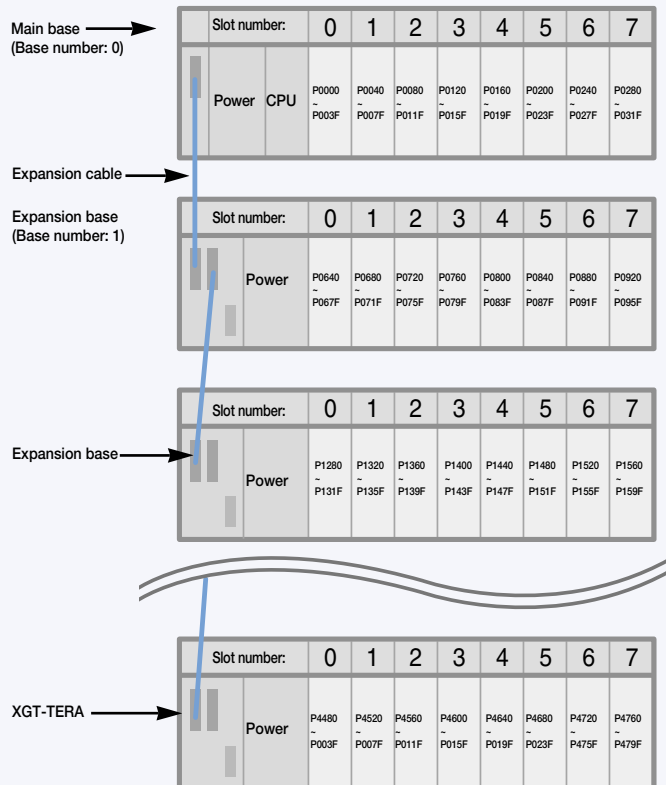

XGT-TERA should be installed at the end of the last expansion base.

Features

- 8, 16, 32, 64 points I/O module
- Operation monitoring by LED display
- Easy maintenance: Terminal block type, one-touch installation of module



Input module specifications

Input type		DC input						AC input		
Type		XGI-D21A	XGI-D22A	XGI-D22B	XGI-D24A	XGI-D24B	XGI-D28A	XGI-D28B	XGI-A12A	XGI-A21A
Input point		8	16		32		64		16	8
Rated input voltage		DC24V						AC100~120V	Free voltage	
Rated input current		4mA						8mA	17mA	
ON voltage/current		19V or more / 3mA or less						AC80V or more / 5mA or less	AC130V or more / 10mA or less	
OFF voltage/current		DC11V or more / 1.7mA or less						AC30V or more / 1mA or less	AC60V or more / 2mA or less	
Response	Off→On	1ms/5ms/10ms/20ms/70ms (set by CPU parameter) Initial value: 3ms						15mA or less		
	On→Off	1ms/5ms/10ms/20ms/70ms (set by CPU parameter) Initial value: 3ms						25mA or less		
Common (COM)		8 points/COM	16 points/COM		32 points/COM		16 points/COM	8 points/COM		
Insulation method		Photocoupler								
Current consumption (mA)		20	30		50		60	30	20	
Weight (Kg)		0.1	0.12		0.1		0.15	0.13	0.13	

Output module specifications

Input type		Relay			Transistor				Triac		
Type		XGQ-RY1A	XGQ-RY2A	XGQ-RY2B	XGQ-TR2A	XGQ-TR2B	XGQ-TR4A	XGQ-TR4B	XGQ-TR8A	XGQ-TR8B	XGQ-SS2A
Output point		8	16		16		32		64		16
Rated load voltage		DC12/24V, AC110/220V				DC12/24V				AC110/220V	
Rated output current	1 point	2A		0.5A		0.1A		0.6A			
	Common	5A		4A		2A		4A			
Response time	Off→On	10ms or less			1ms or less				1ms or less		
	On→Off	12ms or less			1ms or less				0.5cycle +1ms or less		
Common (COM)		1 point/COM	16 points/COM		32 points/COM				16 points/COM		
Insulation method		Relay			Photocoupler						
Current consumption (mA)		260	500		70		130	230		300	
Weight (Kg)		0.13	0.17	0.19	0.11	0.1		0.15	0.2		
Surge killer		-		Varistor		Zener diode				Varistor	
External power supply		-			DC				-		

Note) B1, B2 of 32, 62 points terminal (connector) are shorted inside of the product.

Wiring diagram for input modules

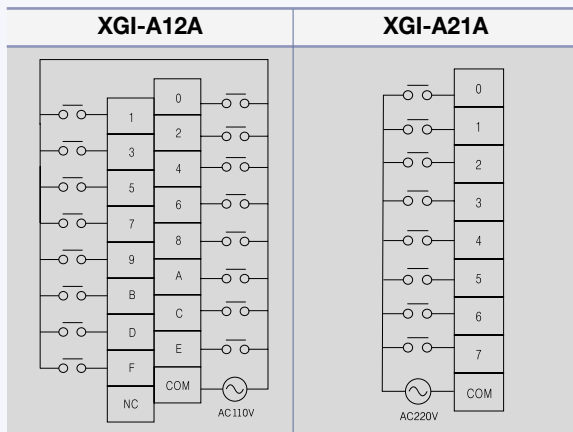
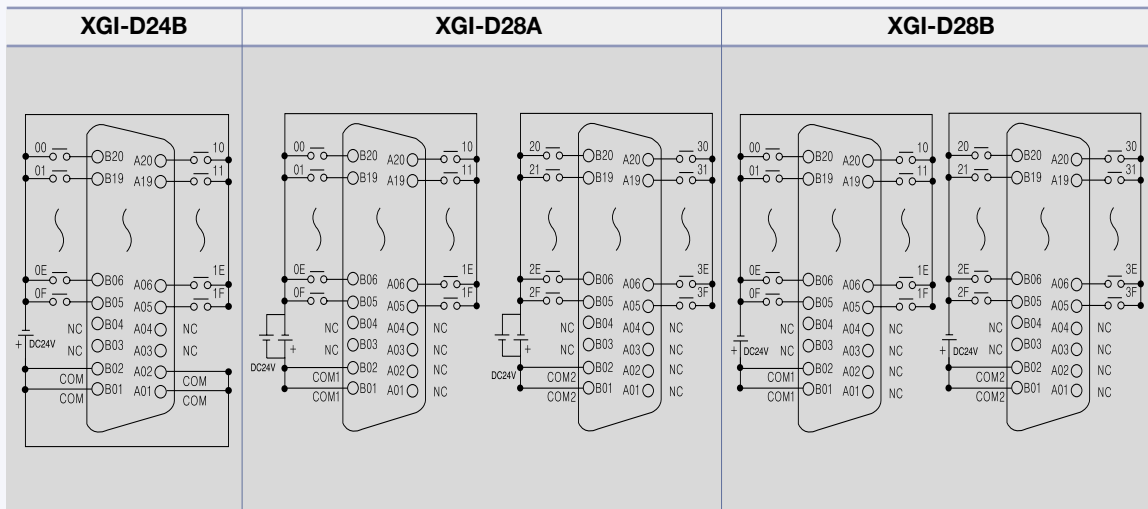
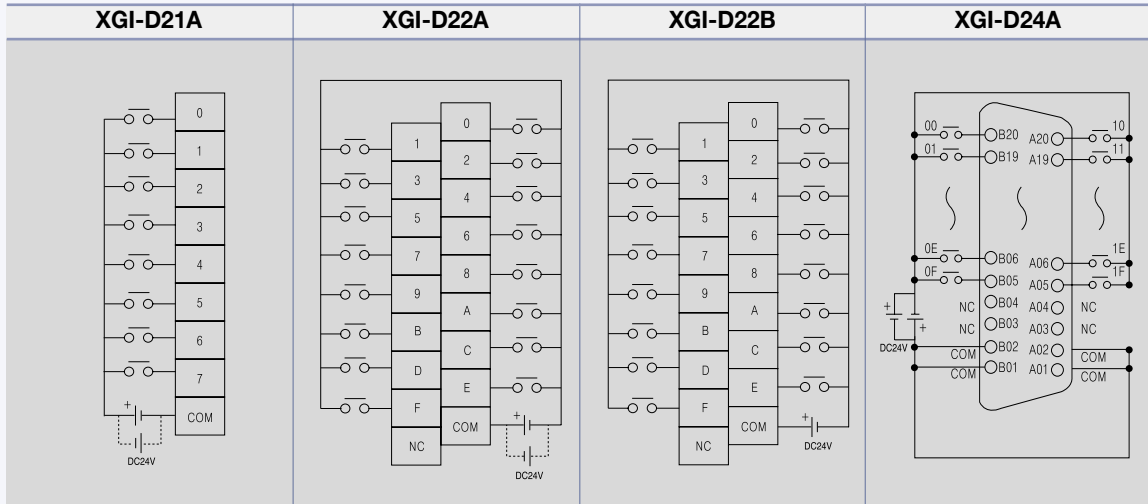

Wiring diagram for output modules

CPU

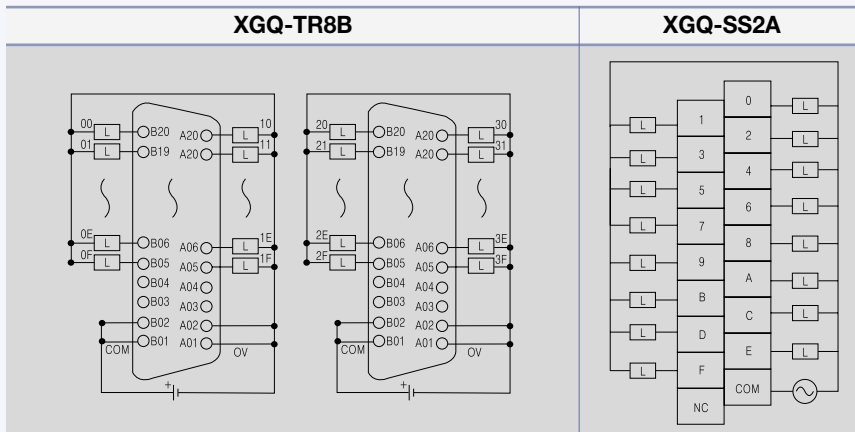
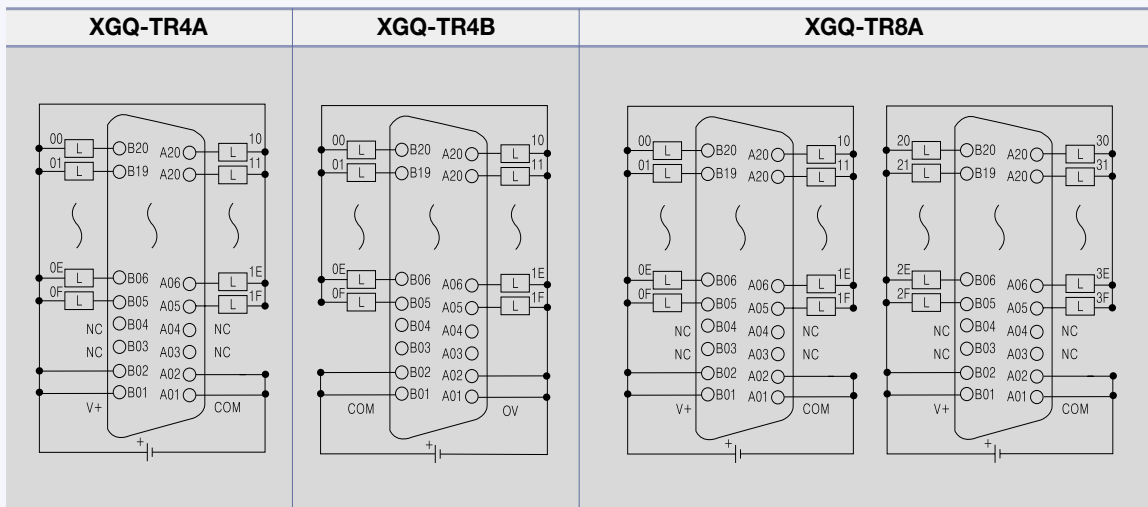
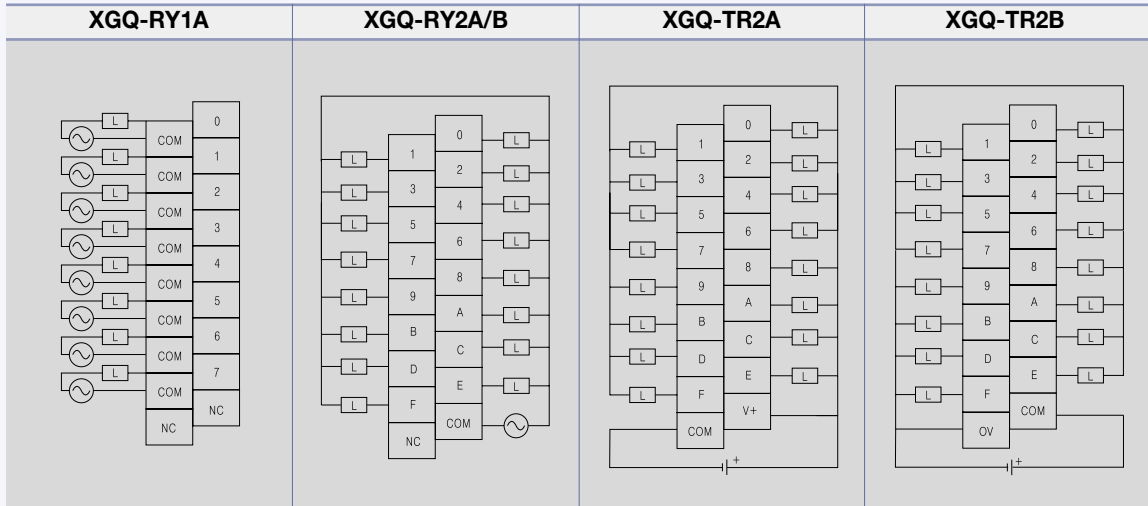

Input/output mixed type (XGH-DT4A)

Input		Output	
Input points	16 points	Input points	16 points
Insulation method	Photo coupler	Insulation method	Photo coupler
Rated input voltage	DC24V	Rated input voltage	DC12/24V
Rated input current	4mA	Rated input current	DC10.2~26.4V
Input voltage range	DC20.4~28.8V	Input voltage range	0.1A/point, 1.6A/COM
Insulation pressure	AC560Vrms / 3Cycle	Insulation pressure	0.1mA or less
On voltage/current	DC19V or more / 3mA or more	On voltage/current	0.7A/10ms or less
Off voltage/current	DC11V or more / 1.7mA or more	Off voltage/current	Zener diode
Input resistance	5.6 kΩ	Input resistance	DC 0.2V or less
Response	Off→On (Setting by CPU parameter) Initial value: 3ms	Response	Off→On 1ms or less
	On→Off (Setting by CPU parameter) Initial value: 3ms		On→Off 1ms or less (rated load, resistance load)
Common (COM)	16 points/COM		
Operation display	LED lighting when output is ON		
Internal current consumption	100mA		
External connection	40-point connector		
Weight (kg)	0.1		

Wiring diagram for mixed type

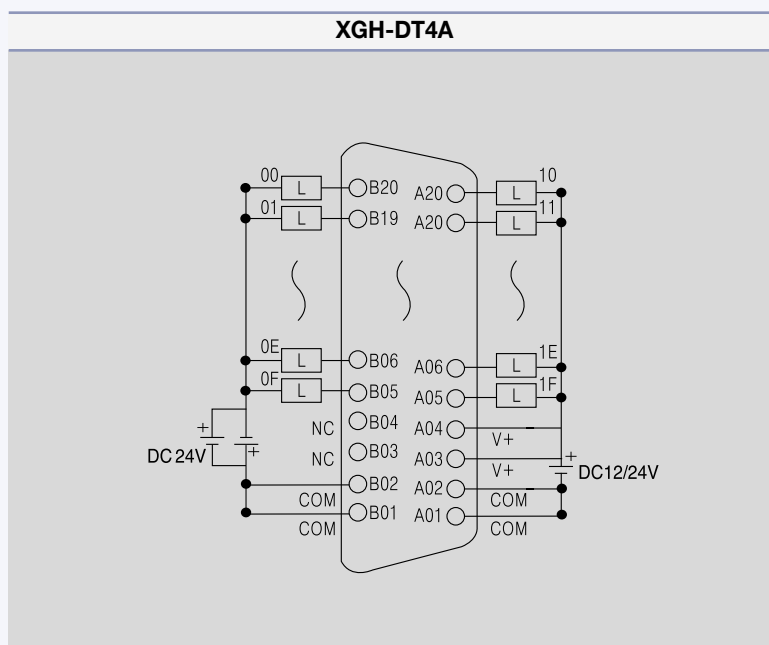

* Input address for XGK CPU is P00~P0F and Output address is P10~P1F when it is installed on the slot 0.
 Input address for XGI CPU is %IX0.0.0~%IX0.0.15 and Output address is %QX0.0.16~%QX0.0.31

Precaution during installation of I/O module

- XGT has 2 kinds of digital input type: Current sink input, Current source input. For DC input module has different wiring depending on the input type, digital input type should be selected with consideration about connected input device.
- Max. number of simultaneous input point differs according to the module type. Therefore, review specification of input module before its application.
- Use an interrupt module when a response of high-speed input is demanded. But only one interrupt module can be installed per CPU module.
- If switching frequency is high or inductive switching load is used, the lifespan of relay output module will be reduced. Therefore, it is recommended to use transistor output module or triac output module.
- When driving an inductive load with output module, set the maximum switching frequency as 'ON' for 1 second and 'OFF' for 1 second.
- When using counter or timer with DC/DC converter, it is possible to have inrush current which cause a break down. Therefore to reduce an effect of inrush current, connect resistor or inductor to load or use the module whose max. load current is high.

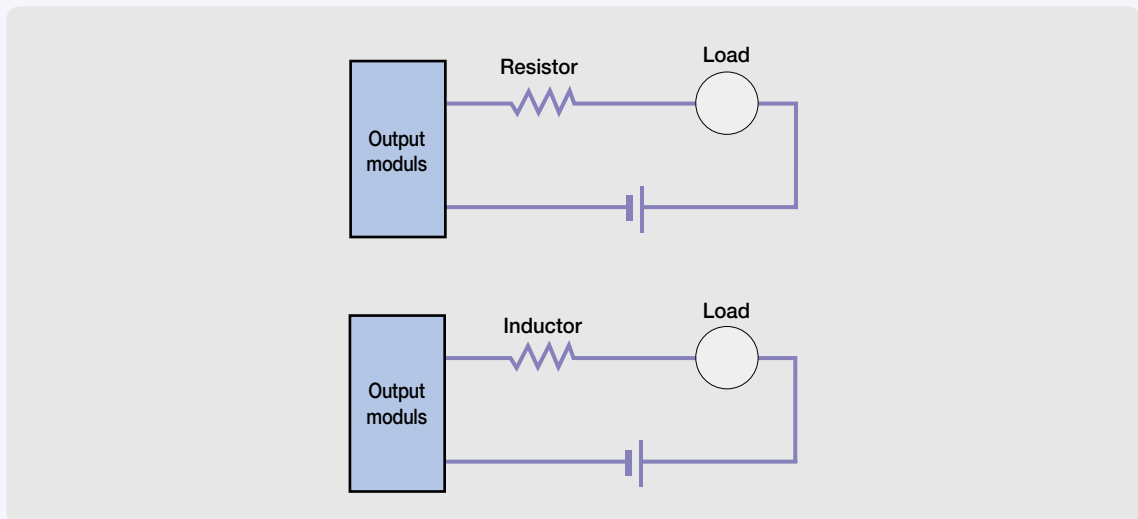

- Fuse of output module is not exchangeable to prevent a damage of external wiring when output module has a short-circuit.
- The number of simultaneous 'ON' points varies depending on input voltage, ambient temperature. Refer to the specification of input module.

- The following graph presents the relay lifespan of relay output module. It shows the maximum lifespan of relay which is used in the relay output.

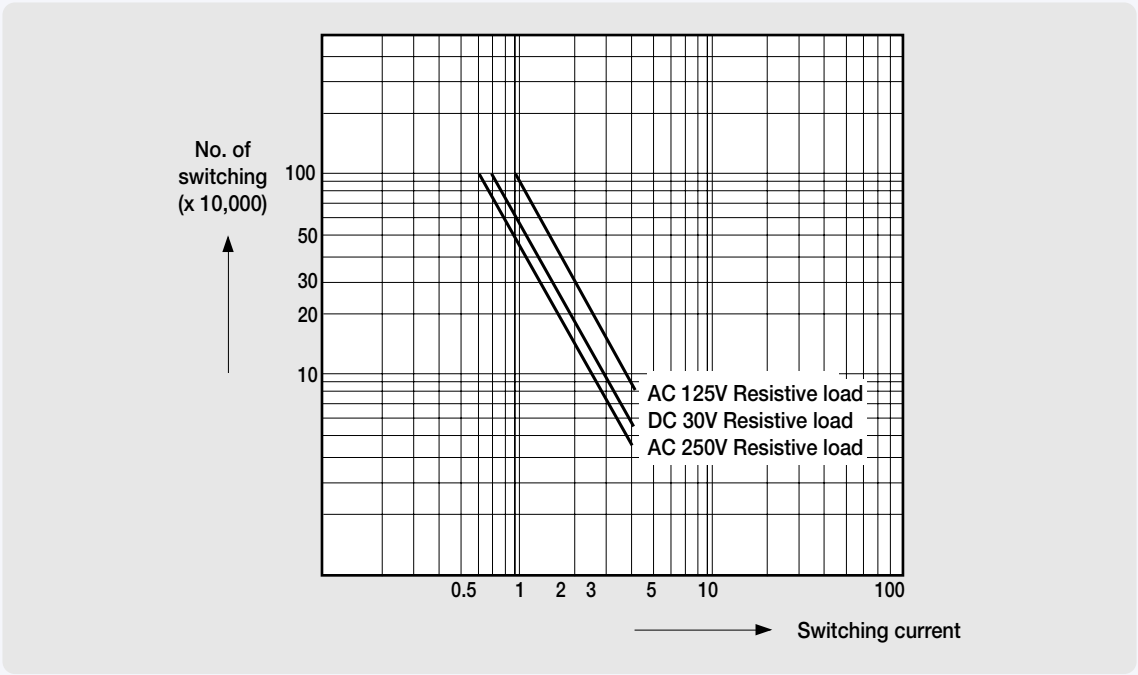

- Compressed terminal attaching sleeve cannot be mounted to XGT terminal block. The following picture shows appropriate compressed terminals for terminal block.

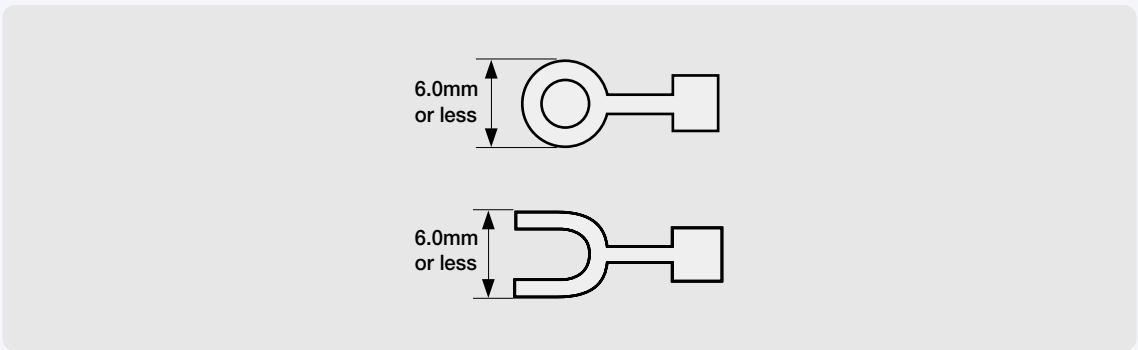

- Use 0.3~0.75mm² twisted pair, below 2.8mm thickness cable for connecting to terminal block.
- Be careful when choosing and using the cable since the permissible current differs according to the insulation thickness.
- Joint torque of fixed screw and terminal block screw of the module needs to be within the range in the following table.

Joint	Joint torque range
I/O module terminal block screw (M3)	42~58 N · cm
I/O module terminal block fixed screw (M3)	68~89 N · cm

- Thermal protector is built in transistor module. Thermal protector is a function that protects PLC from an overload and overheating.



XGR



Redundancy system

Redundancy system for high-speed process control based on IEC



- Processing speed: 42ns/step
- I/O Points: Max. 131,072
- Total memory: 32MB (Program 7MB, Data 2MB, Reserved 7MB, Flash 16MB)
- Switching over time: 50ms
- Built-in 256 PID loops control



High performance

- Processing speed: 42ns/step
- CPU synchronization via fiber optic cable
- I/O Points: Max. 131,072
- Total memory: 32MB (Program 7MB, Data 2MB, Reserved 7MB, Flash 16MB)
- Switching over time: 50ms

Easy expansion installation using network

- Max. 31 expansion base
Distance: Fiber 2km (Max. expansion 60km), Twisted pair 100m (Max. expansion 3km)
- Program upload and download via expansion base
- No limit to install the communication master on the expansion base

Enhanced maintenance via system history and network ring configuration

- Convenient system analyze using Operation history, Error history, System history
- Ring configuration to prevent a line disconnection error
- Network monitoring, Protocol monitoring function
- Error channel monitoring via flag
- Graphic display for the system configuration
- Safe module exchange via Wizard

IEC 61131-3 Standard language

- LD, ST, SFC, IL (read only)
- Program configuration and data type based on IEC

Variety of communication function

- Easy interface using Open network (Ethernet, Profibus-DP, DeviceNet, RS-232C, RS-422/485, etc)
- Max. 24 communication module installation on the expansion base (High speed link 12, P2P 8)
- Network diagnosis via network and frame monitoring
- PLC link via dedicated communication base on Ethernet (RAPIEnet)

Variety of input and output module

- 8 / 16 / 32 / 64 points (8 / 16 points Relay output)
- Input / Output / Mixed module

Enhanced analog function

- Enable to install the analog module on the expansion base (Max. 250, Analog input 139)
- Insulated type and Temperature module
- Easy to set the parameter via I/O parameter and flag
- Debugging function via special module monitoring

Integrated programming & engineering environment

- XG5000 : Easy to program, various monitoring functions and enhanced editing function
- XG-PD : Convenient setup for communication and network parameter
- XG-PDAPM software package: Software package for positioning module

XGR Configuration

- Base, Power, CPU, Network redundancy
- Dual port and 3 kinds of media (Twisted-Twisted, Optic-Optic, Twisted-Optic)



System

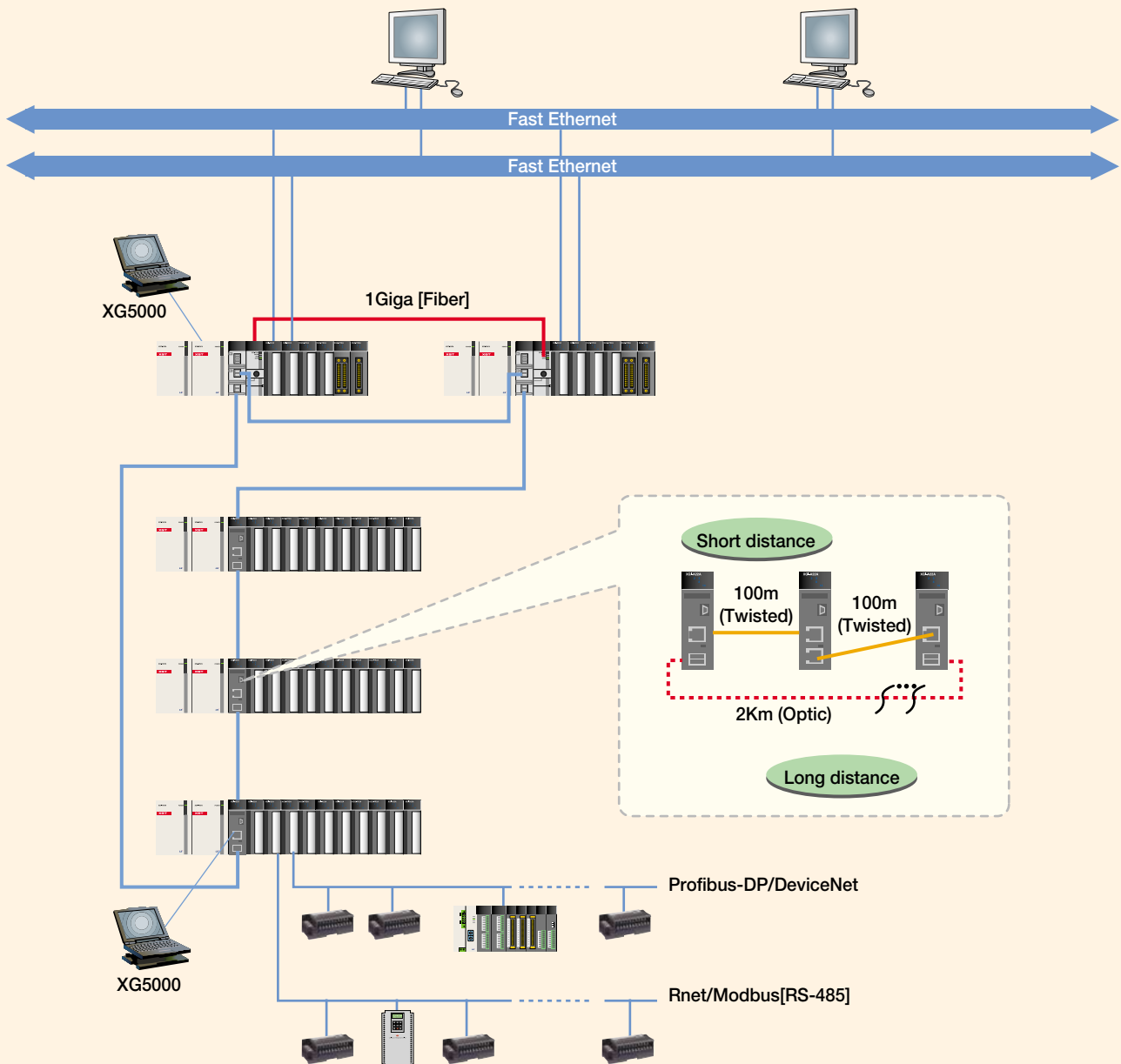

Redundancy system / System configuration method

System configuration

Fiber-optic

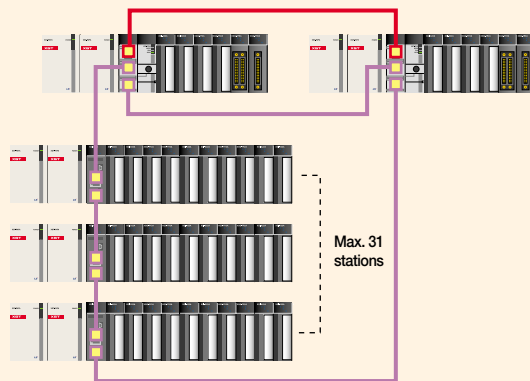

XGR-CPUH/F

- Main CPU
- Fiber optic: Max. distance 2Km



XGR-DBSF

- Expansion drive module
- Fiber optic: Max. distance 2Km (Installed on the expansion base)
- Max. 31 stations

Twisted pair

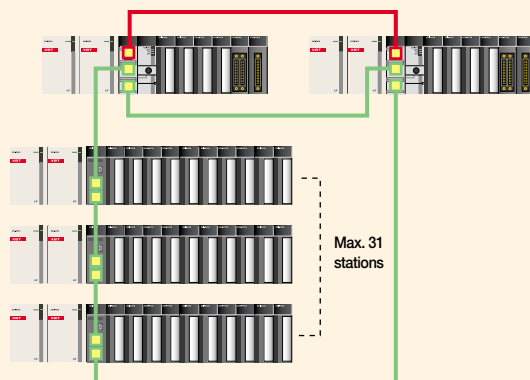

XGR-CPUH/T

- Main CPU
- Twisted fair: Max. distance 100m



XGR-DBST

- Expansion drive module
- Twisted fair : Max. distance 100m (Installed on the expansion base)
- Max. 31 stations

Hybrid (Twisted pair + Fiber Optic)

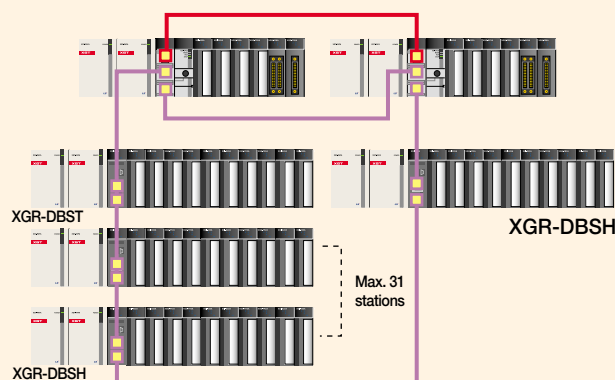

XGR-CPUH/T XGR-CPUH/F

- Main CPU
- Fiber optic: Max. distance 2Km
- Twisted fair: Max. distance 100m



XGR-DBSH

- Expansion drive module
- Fiber optic: Max. distance 2Km
- Twisted fair: Max. distance 100m (Installed on the expansion base)
- Max. 31 stations

* Max. expandable distance: Fiber optic 60km, Twisted fair 3km
 * CPU synchronization cable: 2m, 5m

System configuration

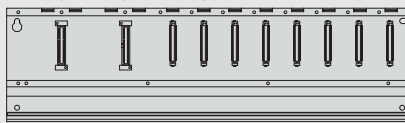
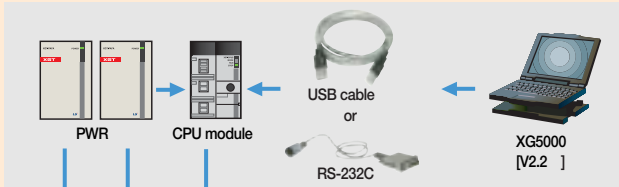

Main base [A Side] XGR-M06P



Main base [B Side] XGR-M06P

Main base

- 2 types of CPU (Fiber optic, Twisted fair)
- Power: AC110V, AC220V
- 6slot base: enable to install 6 communication modules

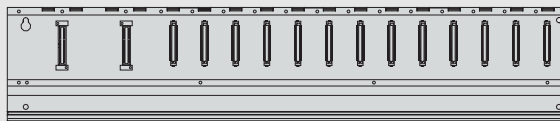
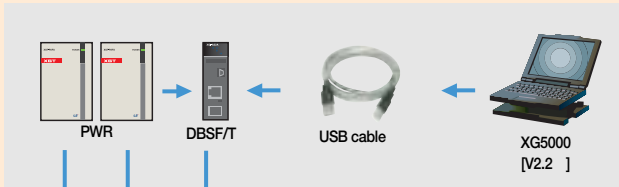

Expansion base XGR-E12P

Expansion base

- Power: 8.5A/AC110V, 8.5A/AC220V
- Expansion drive: Fiber optic, Twisted fair, Hybrid
- EFM* and EIM*: not available with 12slot base

CPU module	
Type	I/O point
XGR-CPUH/T [Twisted fair]	131,072 points
XGR-CPUH/F [Fiber optic]	

Type	I/O point
USB-301A	USB downloading cable
K1C-050A	RS232C downloading cable
XGC-F201	CPU synchronization cable: 2m
XGC-F501	CPU synchronization cable: 5m

Power	
Type	I/O point
XGR-AC12	110V 5.5A (Main base)
XGR-AC13	110V 8.5A (Expansion base)
XGR-AC22	220V 5.5A (Main base)
XGR-AC23	220V 8.5A (Expansion base)

Base	
XGR-M06P	6Slot [Main base]
XGR-E12P	12Slot [Expansion base]

Expansion drive	
XGR-DBST	Fiber optic - Fiber optic
XGR-DBSF	Twisted fair - Twisted fair
XGR-DBSH	Twisted fair - Fiber optic

Item	Input module		
	AC110V	AC220V	DC24V
8 points	-	XGI-A21A	XGI-D21A
16 points	XGI-A12A	-	XGI-D22A
	-	-	XGI-D22B
32 points	-	-	XGI-D24A
	-	-	XGI-D24B
64 points	-	-	XGI-D28A
	-	-	XGI-D28B

Item	Output module		
	Relay	Triac	Transistor
8 points	XGQ-RY1A	-	-
	XGQ-RY2A	XGQ-SS2A	XGQ-TR2A
16 points	XGQ-RY2B	-	XGQ-TR2B
32 points	-	-	XGQ-TR4A
	-	-	XGQ-TR4B
64 points	-	-	XGQ-TR8A
	-	-	XGQ-TR8B

Item	Input/Output mixed module	
	16-point DC input	16-point TR output

Special module			
Analog input	XGF-AV8A	Voltage input type, 8Ch	
	XGF-AC8A	Current input type, 8Ch	
	XGF-AD8A	Voltage/ Current input, 8Ch	
	XGF-AD4S	Voltage/ Current input, 4Ch (Isolated)	
Analog output	XGF-AD16A	Voltage/ Current input, 16Ch	
	XGF-DV4A	Voltage output type, 4Ch	
	XGF-DC4A	Current output type, 4Ch	
	XGF-DV8A	Voltage output type, 8Ch	
	XGF-DC8A	Current output type, 8Ch	
	XGF-DV4S	Voltage output, 4Ch (Isolated)	
	XGF-DC4S	Current output, 4Ch (Isolated)	
	High-speed counter	XGF-HO2A	Pulse (OC) input type, 2Ch
XGF-HD2A		Pulse (LD) input type, 2Ch	
XGF-PO3A		Pulse (OC) output type, 3 axes	
XGF-PO2A		Pulse (OC) output type, 2 axes	
XGF-PO1A		Pulse (OC) output type, 1 axis	
Positioning		XGF-PD3A	Pulse (LD) output type, 3 axes
	XGF-PD2A	Pulse (LD) output type, 2 axes	
	XGF-PD1A	Pulse (LD) output type, 1 axis	
	Temperature control	XGF-TC4S	Thermocouple input, 4Ch
		XGF-RD4A	RTD input, 4Ch
		XGF-RD4S	RTD input, 4Ch (Insulated)
Temperature control module	XGF-TC4UD	Temperature controller, 4 loops, Universal input	

Communication module		
RAPIEnet	XGL-EIMT	RAPIEnet Twisted fair 2Ch
	XGL-EIMH	RAPIEnet Fiber optic/Twisted fair 1Ch
	XGL-EIMF	RAPIEnet Fiber optic 2Ch
	XOL-EIMT	RAPIEnet Twisted fair 2Ch For PC
Cnet	XOL-EIMF	RAPIEnet Fiber optic 2Ch For PC
	XGL-CH2A	RS-232C/RS-422
	XGL-C22A	RS-232C, 2Ch
Ethernet (Open)	XGL-C42A	RS-422, 2Ch
	XGL-EFMF	Fiber optic, Master, SC type
	XGL-EFMT	Twisted pair, Master, RJ-45
	XGL-ESHF	Fast Ethernet, Industrial Ring module
Ethernet (Dedicated)	XGL-EHST	Fast Ethernet, Switching hub
	XGL-EDMF	Fiber optic, Master, SC type
Rnet	XGL-EDMT	Twisted pair, Master, RJ-45
DeviceNet	XGL-RMEA	Rnet, Master, TP
Profibus-DP	XGL-DMEA	DeviceNet, Master
	XGL-PMEA	Profibus-DP, Master

Specification

Item		Description		Remark
		XGR-CPUH/F	XGR-CPUH/T	
Media		Fiber optic	Twisted pair	
Operation method		Cyclic execution, Periodic operation, Interrupt operation, Fixed scan		
I/O control method		Scan synchronized batch processing method (Refresh method)		
Program language		LD (Ladder Diagram), ST (Structured Text), SFC (Sequential Function Chart), IL (Read only)		
Number of Instructions	Operator	18		
	Standard function	130 + Real type function		
	Standard function block	41		
Special function/ function block		Special function block, Process control function block		
Processing speed	LD	0.042 μ s/Step		
	MOV	0.126 μ s/Step		
	Real type	\pm : 0.602 μ s(S), 1.078 μ s(D) x : 1.106 μ s(S), 2.394 μ s(D) \div : 1.134 μ s(S), 2.66 μ s(D)		S: Real type D: Long real type
I/O points		23,808 points (31 stage *12 slot *64 points)		
I/O memory		I: 131,072 points, Q: 131,072 points (Total: 1131,072)		
DRAM	Program memory	7MB		Including Upload, Parameter, System area *Battery back-up memory: 8MB
	Data memory	2MB		
	Reserved memory	7MB		
Flash memory		16MB		
Data memory	Direct variable	256k Byte		
	Auto allocated variable	512k Byte		
	Timer	No limitation, Range: 0.001sec ~ 4,259,967.295sec (1,193hours)		
	Counter	No limitation, Range: -32,768 ~ +32,767		
	Flag	System	4k Byte	
Communication		64k Byte		L, N area
Special		2k Byte (32 base, 16 slot, 32 channel)		U area: Analog device area R area: read/write (Command, XG5000)
File register		64k Byte *2		
Program	Number of program blocks	256		
	Initial task	1 (_INT)		
	Cycle task	32		
	Internal device task	32		
Operation mode		RUN, STOP, DEBUG		
Restart mode		Warm, Cold		
Self diagnostic functions		Watchdog timer, Memory error, I/O error, Battery error, Power Supply error		
Program download		RS-232C (1CH), USB (1CH)		
Data retain		Auto allocated variable: set by variable definition Direct variable: set by parameter		
Max. expansion base		31 stages		

Specification

Item	Hardware		Remark
CPU module	2 slot / Fiber, Twisted fair		
Expansion drive module	1 slot / Fiber, Twisted fair, Hybrid		
Base	Main base: 6 slot, Expansion base: 12 slot		
Power	AC110V	5V-5.5A	
	AC220V	5V-5.5A	
	AC110V	5V-8.5A	
	AC220V	5V-8.5A	
Expansion method and Max. expansion base		31 stages by network	
Base number setting		Rotary switch of expansion drive module	
Distance between expansion bases		Twisted fair: 100m (3km), Fiber: 2km (60km)	
Master/Standby switching over time		50ms or less	

Available modules for each base

	Base	Available modules
1	Main base	CPU, Ethernet module (XGL-EFMx), RAPIEnet module (XGL-EIMx) * x: T (Twisted fair), F (Fiber optic), H (Hybrid)
2	Expansion base	I/O modules for XGI (Ethernet based communication module should be installed on Main base Number of communication module: 12 for High-speed link, 8 for P2P Number of analog module: Analog input (139), Analog output (250)

Water power generation or Dam door control

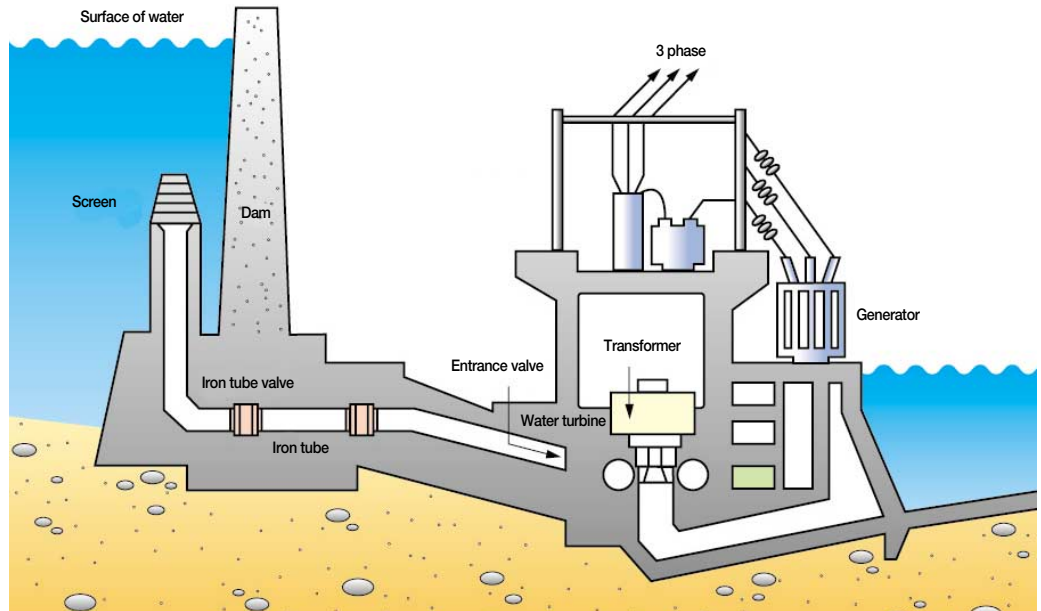

System configuration

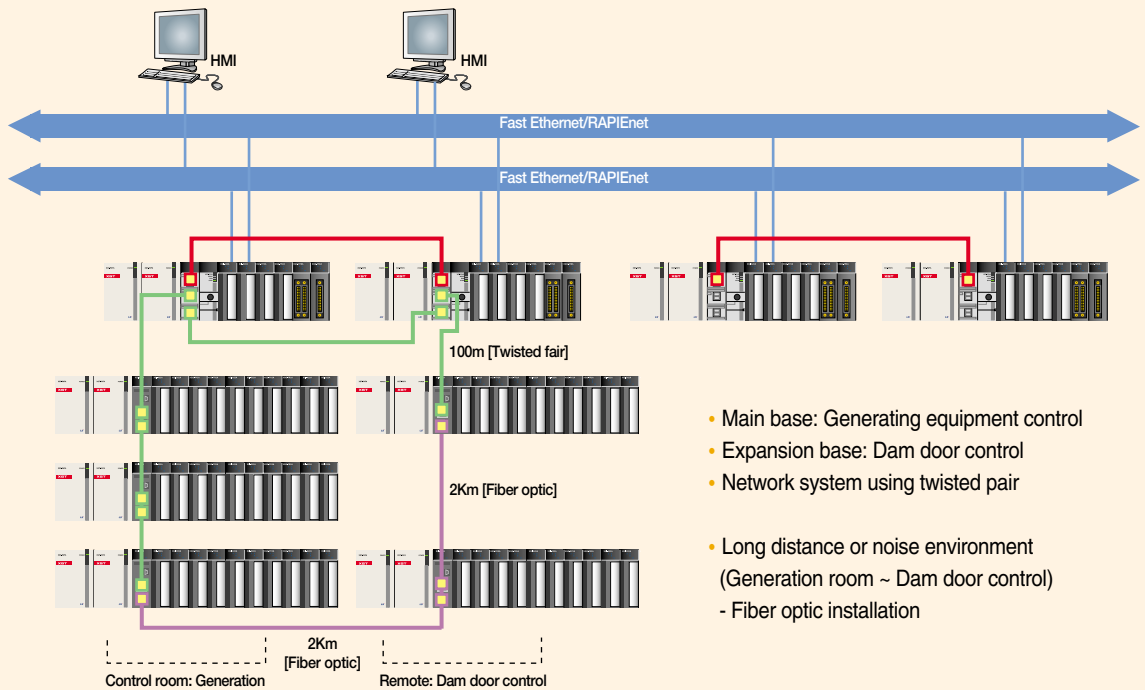

Generating boiler control

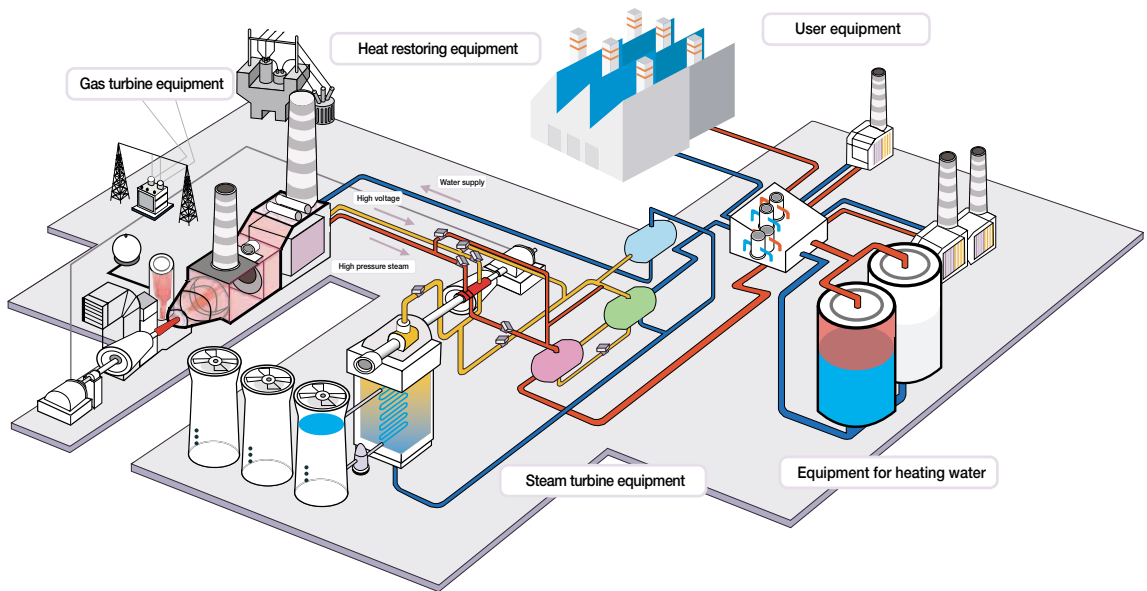

System

System configuration

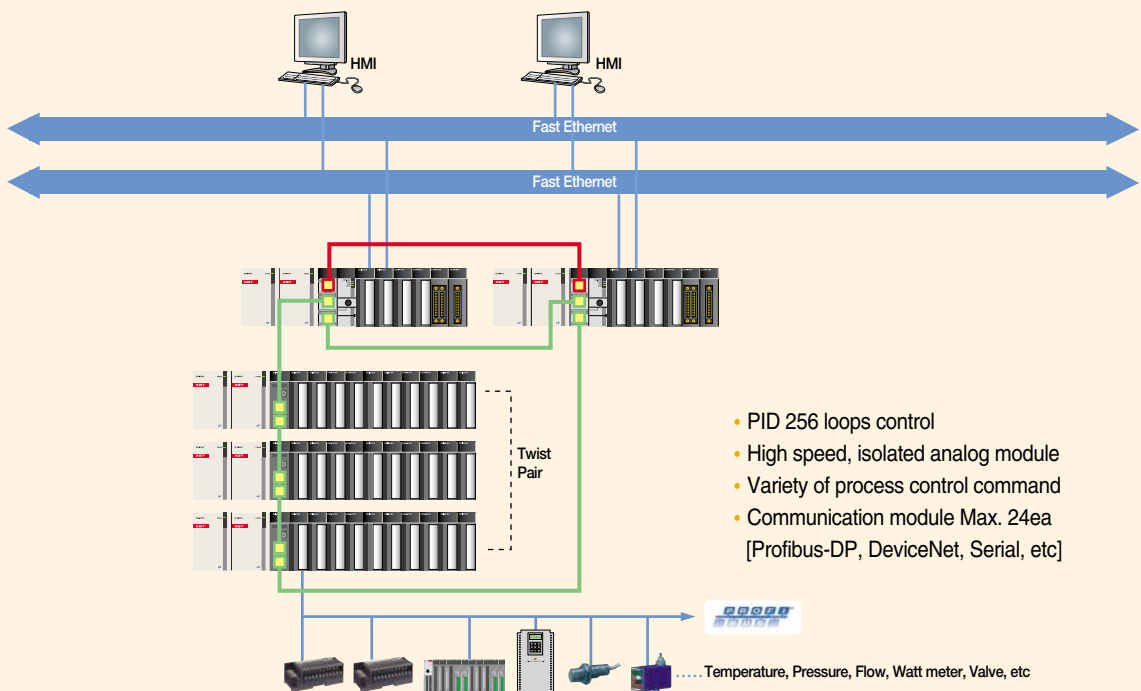

Stage control

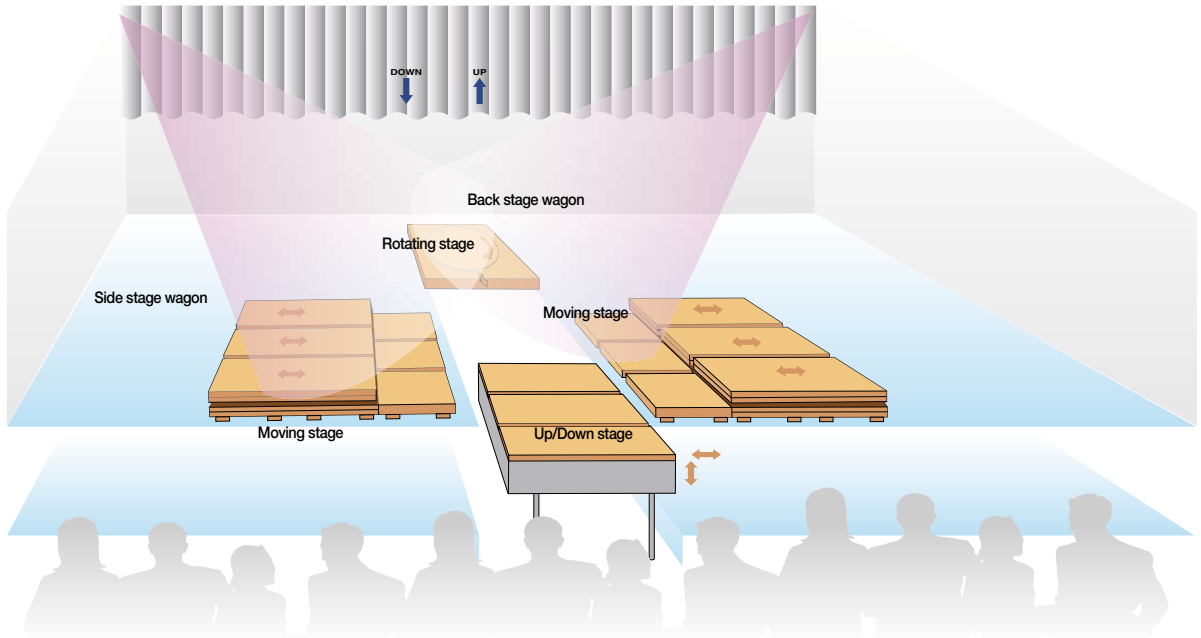

System configuration

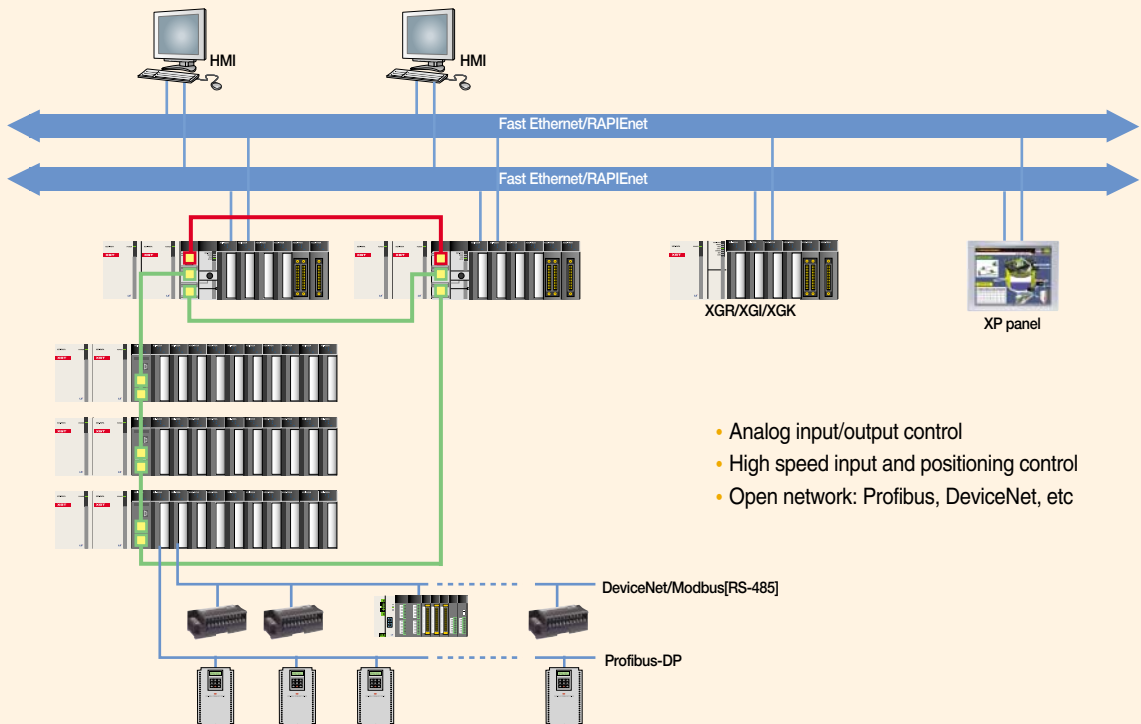

Water processing control

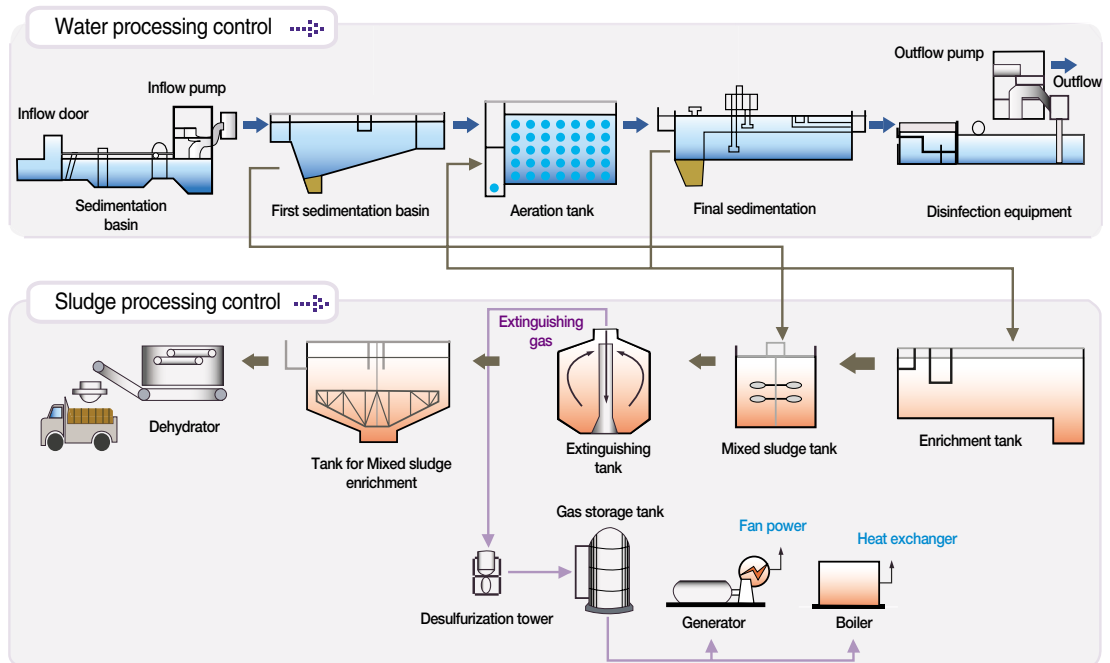

System configuration

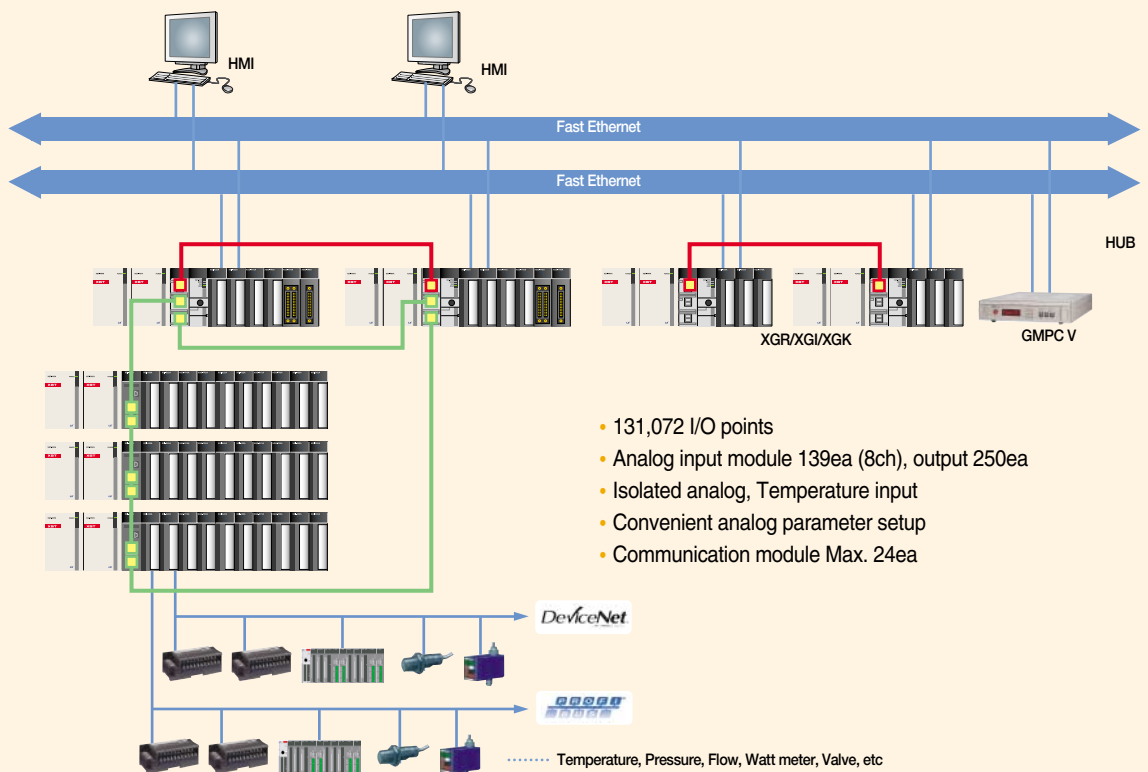

Incinerator control

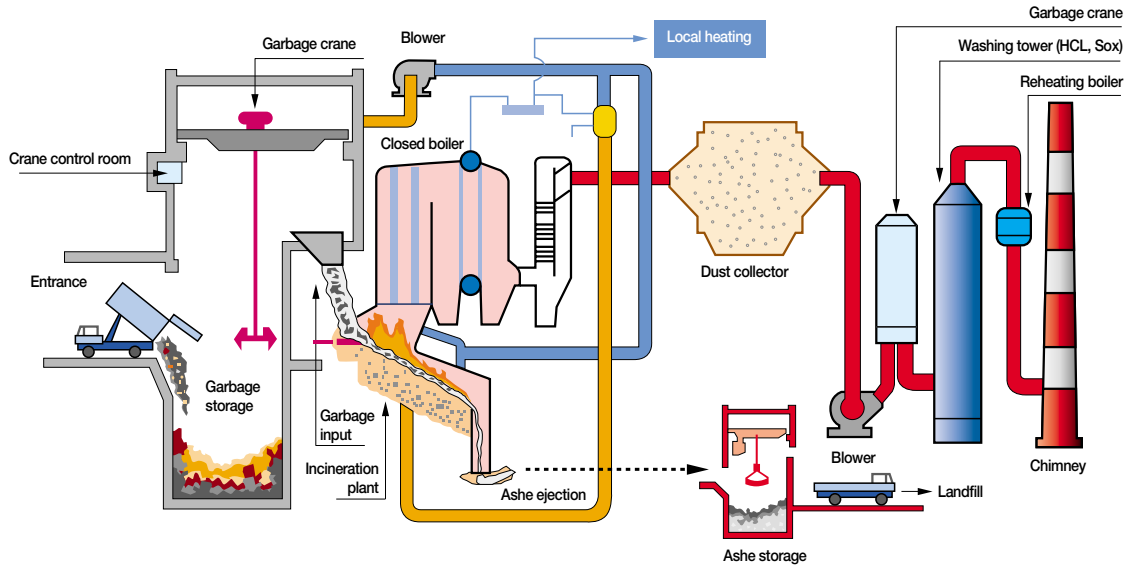

System configuration

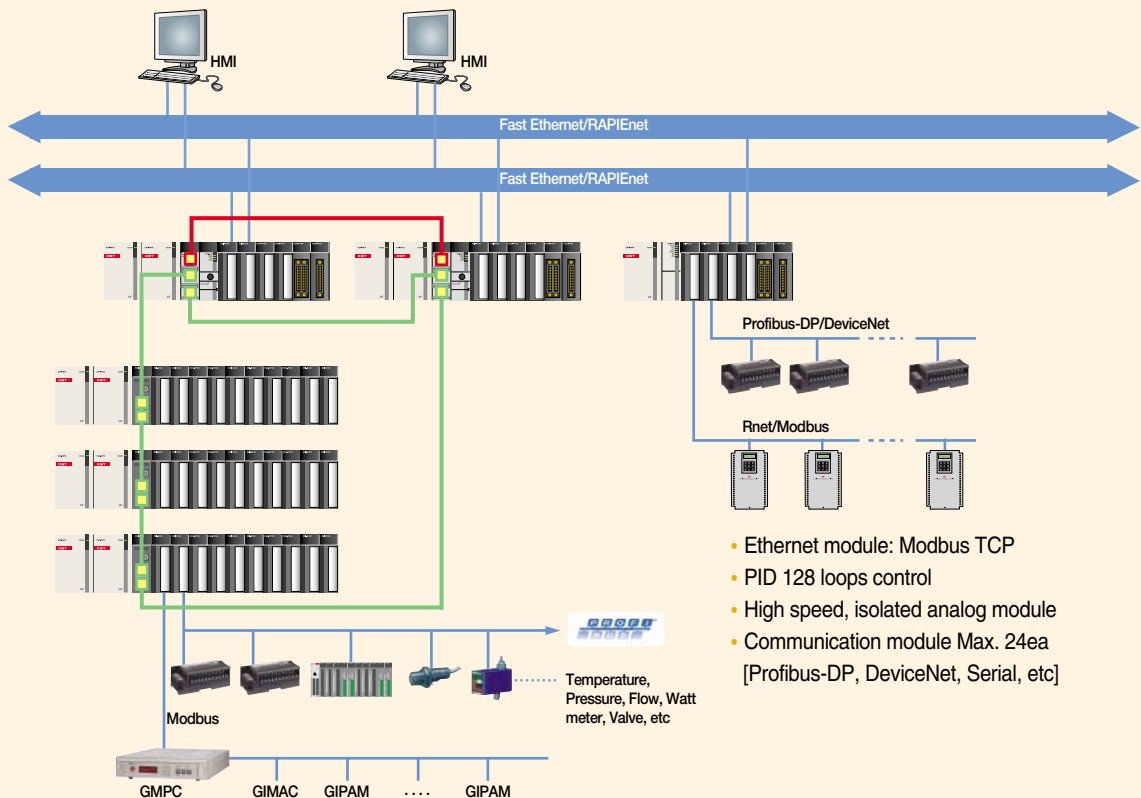

Broad casting system

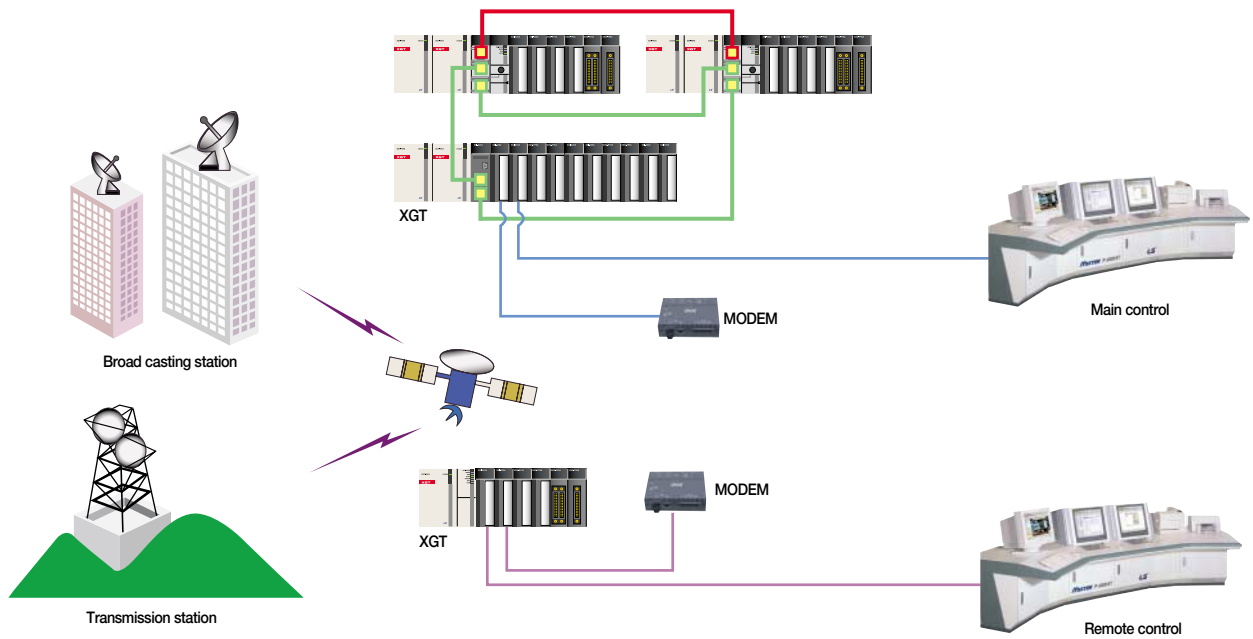

System configuration

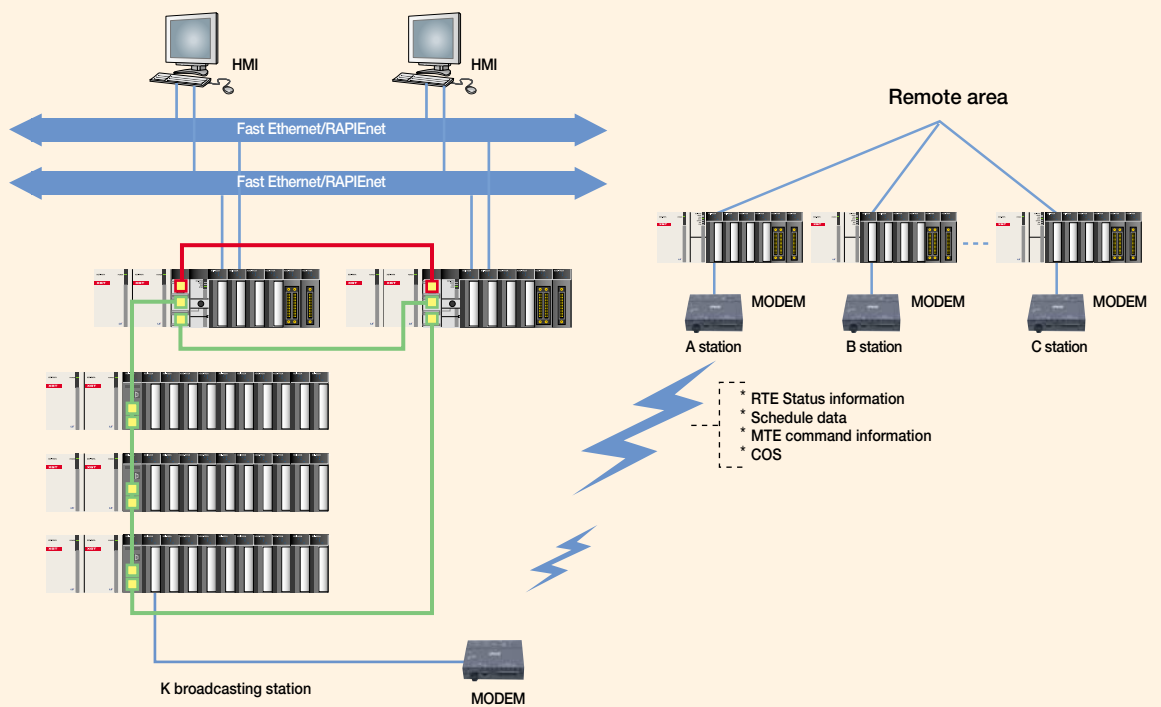



Network

Network

Along with Ethernet, Profibus-DP, and DeviceNet, XGT series provide the maximum in control integration and communication flexibility.





XGT



RAPIenet

- Communication speed: 100Mbps
- Dual port [T.Pair/F.Optic/Hybrid]
- Built-in high performance industrial switch
- Cyclic Communication[Broadcast Service]
 - 1block:200word
 - Send 64block / Receive 128block
- Event Communication[Peer to Peer Service]

XGT Fast Ethernet

- 10/100Mbps Industrial high-speed Ethernet
- 10/100Base-TX, 100Base-FX (Optical)
- Open Ethernet (FEnet) and LSIS dedicated Ethernet (FDEnet)
- High reliability and performance with 32-bit processor
- Various connection to MMI S/W (XGT, MODBUS/TCP)

XGT Cnet

- RS-232C/485/422 communication
- Long-distance communication via modem connection
- Various connection to MMI S/W (XGT, MODBUS RTU, MODBUS ASCII)
- User-defined communication support
- Convenient P2P master (XGT, MODBUS)

XGT Rnet

- Communication speed: 1Mbps
- Communication distance: Max. 750m
- Max. 6 repeaters (up to 5.25km)
- Network management using Auto-scan (Slave module information)

XGT Dnet (DeviceNet)

- Connectable to other PLCs and devices
- Compliance of the ODVA standard
- Flexible communication speed setting: 125/250/500Kbps
- Multi-drop and T branch connection
- Communication distance: Max. 500m
- Convenient parameter setting through SyCon/HS link parameter

XGT Pnet (Profibus-DP)

- Optimum communication for a master automation device and distributed slave I/O devices
- Fast slave communication omitting application layer
- Communication distance: Max. 1200m
- Convenient parameter setting through SyCon/HS link parameter

Features

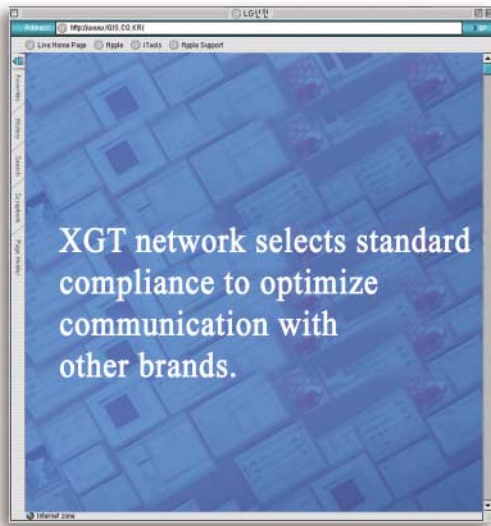

RAPIenet

- Communication speed: 100Mbps
- Dual port (T.Pair / F.Optic / Hybrid)
- Built-in high performance industrial switch
- Cyclic Communication (Broadcast Service)
 - 1block:200word
 - Send 64block / Receive 128block
- H/W based Dual port Full duplex Switching
- Real-time / Non real-time service

XGT Fast Ethernet

- 10/100Mbps Industrial high-speed Ethernet
- 10/100Base-TX, 100Base-FX (Optical)
- Open (Information level) Ethernet: FENet
LSIS dedicated (Between LS PLCs) Ethernet: FDEnet
- High reliability and performance with 32-bit processor
- Various connection to MMI S/W (XGT, MODBUS)
- Enhanced network diagnosis

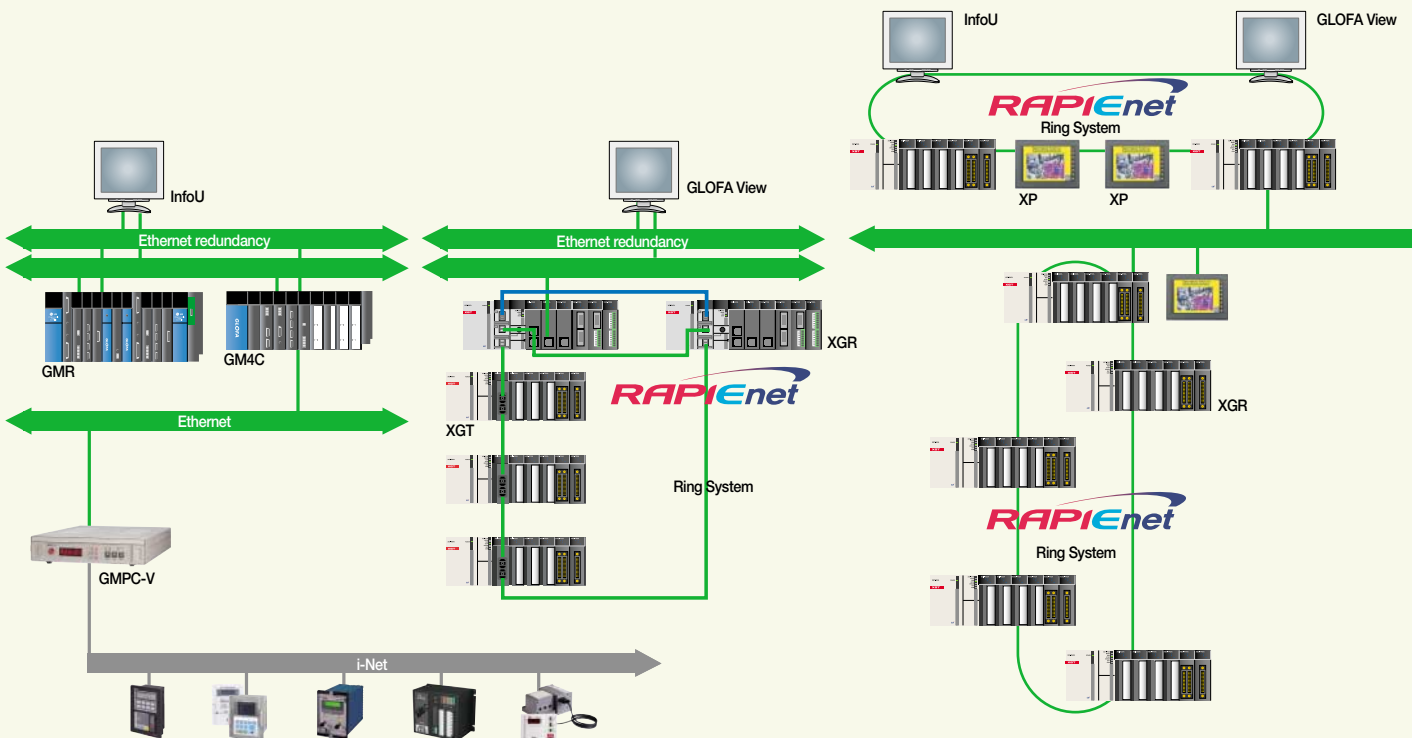

XGT Cnet

- RS-232C/485/422 communication
- Long-distance communication via modem connection
dedicated line modem connection
- Various connection to MMI S/W
(XGT, MODBUS RTU, MODBUS ASCII)
- User-defined communication
- Convenient P2P master (XGT, MODBUS)

XGT Rnet

- High-speed communication: 1Mbps
- Long communication distance: Max. 750m
- Max. 6 repeaters (up to 5.25km)
- Network management using Auto-scan
(Slave module information)

XGT Dnet (DeviceNet)

- Connectable to other PLCs and control device
- Compliance of the ODVA standard
- Flexible communication speed setting: 125/250/500Kbps
- Multi-drop and T branch connection
- Long communication distance: Max. 500m

XGT Pnet (Profibus-DP)

- Optimum communication for a master automation device
and distributed slave I/O devices
- Fast slave communication omitting application layer
- Long communication distance: Max. 1200m
- Communication using High-speed link parameter

No. of network module available

Item	XGK / XGI / XGR CPU
Total network module	24
High-speed link module	12
P2P service	8

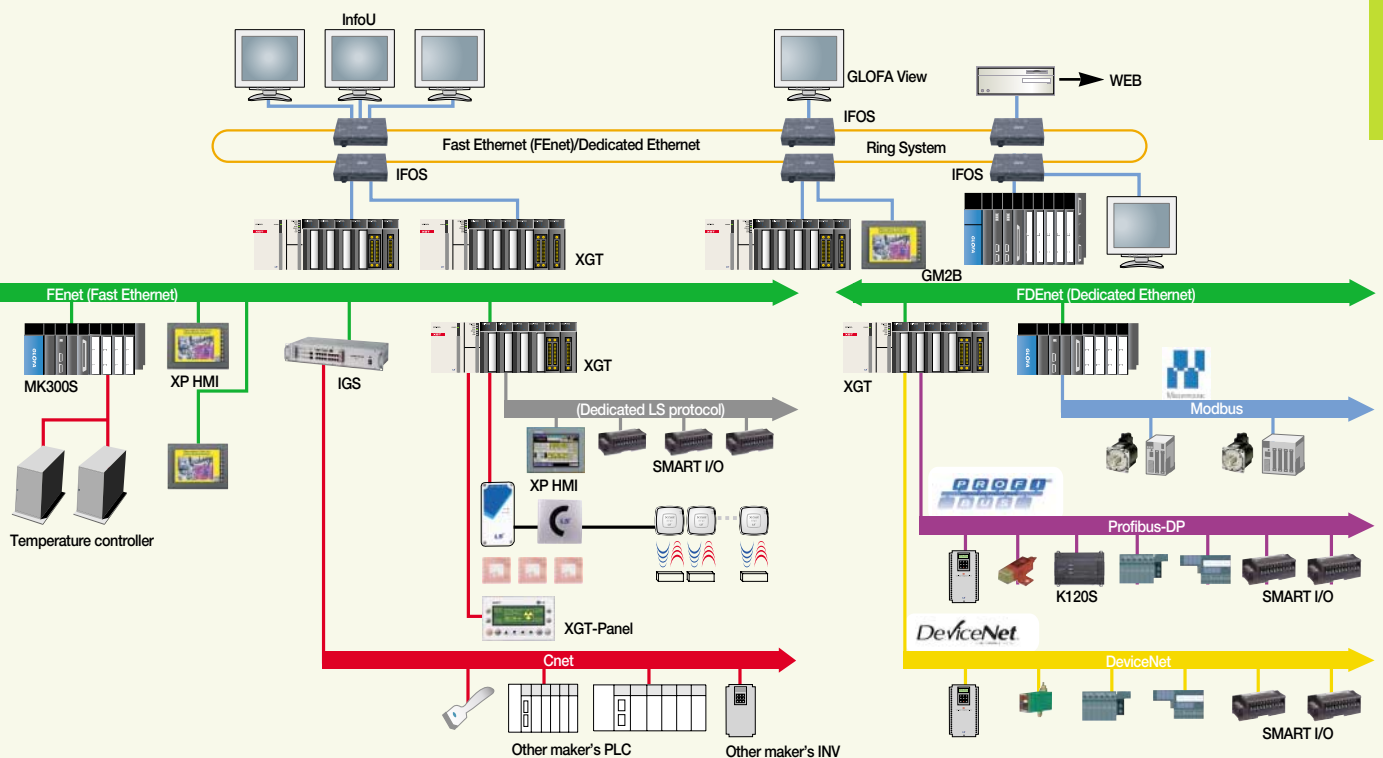

Features

100Mbps Dual Port Ethernet

- Communication speed: 100Mbps
- Dual port (T.Pair / F.Optic / Hybrid)
- Built-in high performance industrial switch
- Cyclic Communication (Broadcast Service)
 - 1block: 200word
 - Send 64block / Receive 128block
- Event Communication (Peer to Peer Service)

Hardware based Full duplex switching

- Dual port full duplex switching (Forwarding/Receiving)
- Real-time / Non real-time service (Frame)

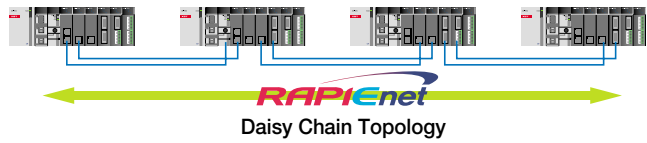
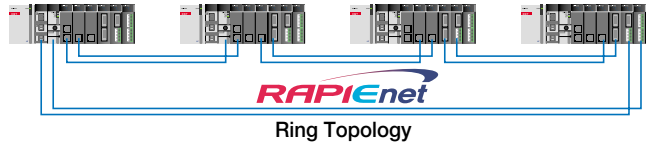

Redundancy System

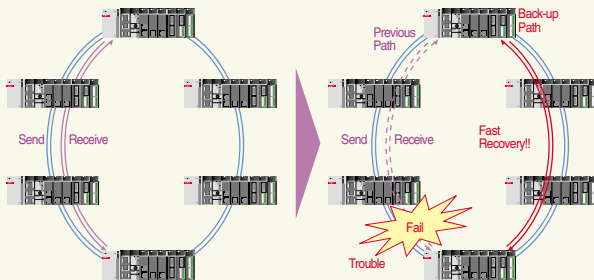

Hybrid System

- Twisted pair, Fiber optic, Hybrid(T.P+F.O)

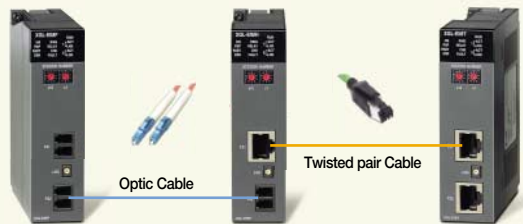

Intelligent Diagnostic Functions

- Alarm for station number collision
- Cable distance measurement (Twisted pair cable)
- Convenient wiring using auto cross over
- Various diagnosis and Network status information
 - (a) CPU status
 - (b) Communication module status
 - (c) Communication service (HS link, Dedicated service, P2P) status
 - (d) Auto scan function to supply module information within the network
 - (e) Packet and Data ring monitoring receiving to Communication module
 - (f) Module diagnosis via network

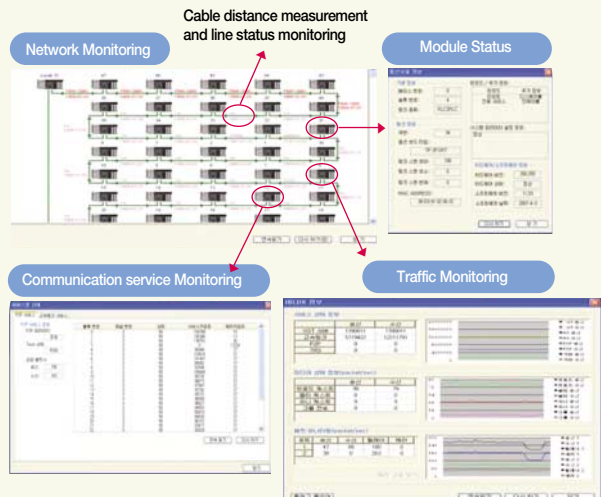

Specification

Item		Specification	
		100BASE-FX	100BASE-TX
Transmission	Transmission speed	100Mbps	100Mbps
	Media	Fiber optic	Twisted pair
	Transmission method	Base band	
	Topology	Daisy Chain, Ring topology	
	Distance (Node to node)	2 km	100 m
	Max. distance (Node to node)	128km	6,400m
	Max. Node	64 nodes	
	Max. Protocol	1,516 bytes	
	Media access method	CSMA/CD	
	Frame error check	CRC 32 = $X^2+X^6+X^9+\dots+X^2+X+1$	
Max. Number of installation	For PLC	12	
	For PC	1	
Mountable slot	For PLC	Main base ~ 7 th Expansion base (XGK-CPUH/XGI-CPUU)	
		Main base ~ 3 rd Expansion base (XGK-CPUA/CPUA)	
		Main base ~ 1 st Expansion base (XGK-CPU)	
For PC	PCI slot		
Communications device	Communication method	P2P Client / Server	High speed link Multicast, Unicast
	Data block	700 word x 64Block	12,800 word
	Data per block	700 word	6,400 word
	PLC ↔ PLC	•	•
Fail Safe	PLC ↔ PC	Available soon	•
	Dual communication line		•
Network diagnosis	Recovery Time		Within 10m
	Bypass of the fail station		•
	Cable distance measurement		•
Dimension (mm)	Station number collision detection		•
	PADT		•
Current consumption (mA)	For PLC	98(H) x 27(W) x 90(D)	
	For PC	18(H) x 120(W) x 174(D)	
Wight (g)	For PLC	Twisted pair: 330, Fiber optic: 670, Mixed: 510	
	For PC	Twisted pair: 630, Fiber optic: 630	
	For PLC	Twisted pair: 102, Fiber optic: 109, Mixed: 105	
	For PC	Twisted pair: 104, Fiber optic: 128	



XGL-EIMF : Fiber optic 2ports
XGL-EIMH : Twisted pair port/ Fiber optic 1 port
XGL-EIMT : Twisted pair 2ports



XGL-EIMF : Fiber optic 2ports For PC

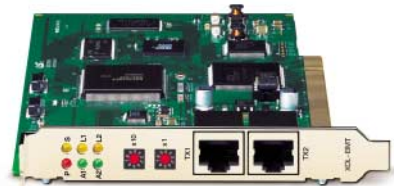

XGL-EIMT : Twisted pair 2ports For PC

Redundancy rack type expansion system

- Built-in type for CPU (Redundancy CPU)
 - Max. 31 expansion base
- Easy installation
 - Base Auto scan
 - Analog module setup with I/O parameter
 - Easy programming for analog using global variable
 - Max. 24 communication module
- Long distance expansion (Fiber optic: 2km) and loader connection
- Twisted pair/ Fiber optic/ Mixed type communication modules for various system environment

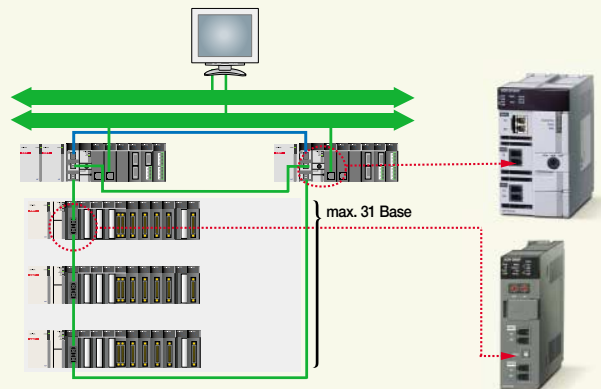

Controller Level communication

- XGK/XGI/XGR PLC2PLC communication
- Enable to configure Daisy chain without External switch
- Service periodic: within 5ms

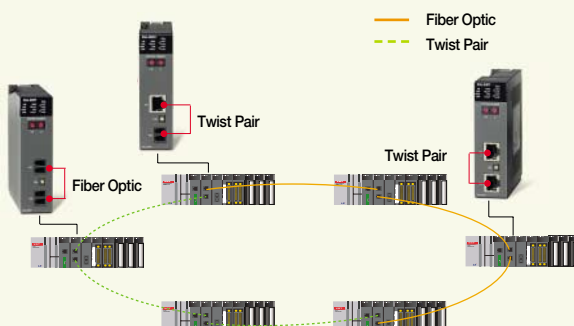

System configuration

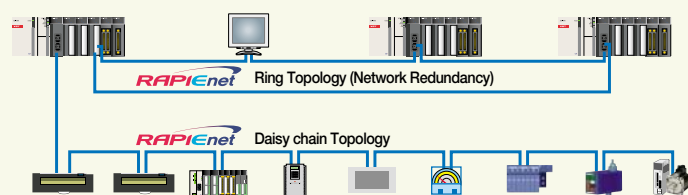

Features

- 10/100Mbps industrial high-speed Ethernet (IEEE802.3)
- High-speed link block (Send 32blocks, Receive 128blocks)
- 10/100Base-TX, 100Base-FX (Fiber optic)
- Open Ethernet and Dedicated protocol
- High performance by 32bit processor
- Remote connection via XG5000
- Module reset function
- Modbus TCP protocol
- Network diagnosis via auto scan
- Easy network configuration and setup via XG-PD
- User defined protocol and P2P service
- PING Test function
- Communication information for services (High speed link, Dedicated service, Media status)

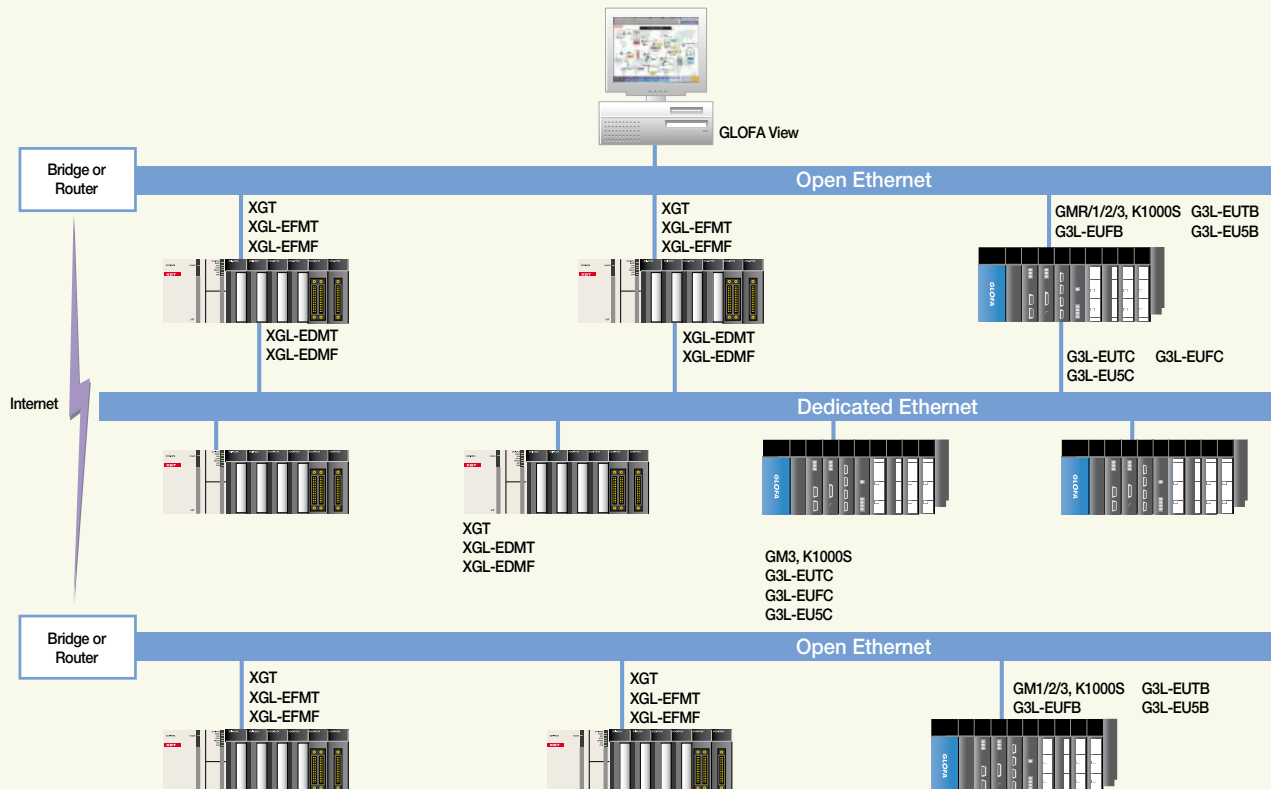

Specification

Open Ethernet	Item	XGL-EFMT	XGL-EFMF
	Communication spec.		10/100 BASE-TX
Protocol		TCP/IP, UDP/IP	
Service	With LS PLCs	High-speed link, P2P service	
	With other devices	P2P service	
	Application	Dedicated protocol service, XG5000 service, E-Mail service	
HS link sending/receiving data		200 words/block (Max. 128 blocks)	
No. of channel connectable to upper stage		16 channels	
General use		Communication with PC (HMI) and external devices, High-speed communication among LSIS PLCs	
Purpose		UTP/STP Category 5	62.5/125 μ m, Multi-mode, SC connector
Current consumption (mA)		410	630
Weight (kg)		0.11	0.15

Dedicated Ethernet	Item	XGL-EDMT	XGL-EDMF
	Communication spec.		10/100 BASE-TX
Protocol		Dedicated protocol	
Service	With LS PLCs	High-speed link, P2P service	
	With other devices	-	
	Application	XG5000 service	
Sending/receiving data		200 words /block	
No. of connection stations		64 stations	
General use		High-speed link communication among LSIS PLCs	
Purpose		UTP/STP Category 5	62.5/125 μ m, multi-mode, SC connector
Current consumption (mA)		410	630
Weight (kg)		0.11	0.15

Network

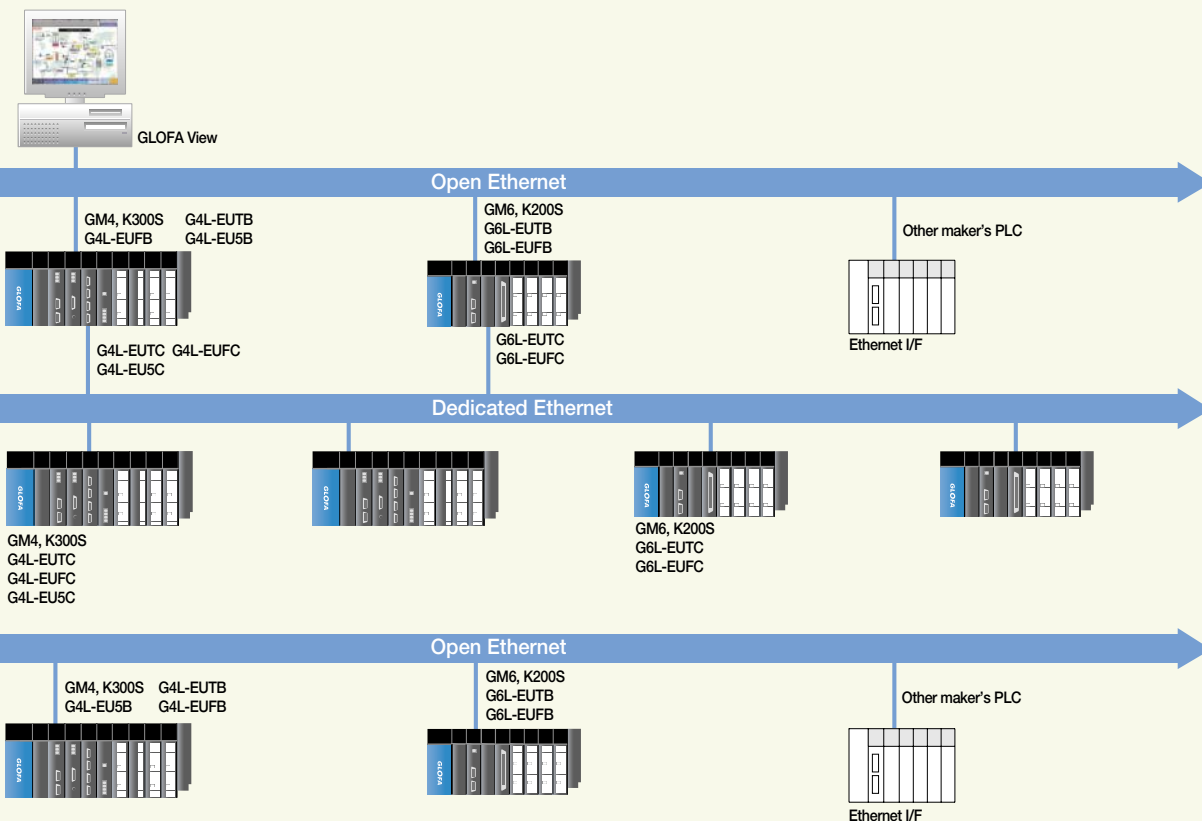

Features

- 100Base-FX media
- Industrial high-speed Ethernet (IEEE802.3)
- High-speed link to communicate between LS PLCs
- High-speed block to link between modules
- High-speed link and Max. 16 P2P communication
- Loader service via Ethernet (XG5000): Dedicated TCP/IP port 2002
- Easy connection to other system using P2P and XG-PD
- Dedicated protocol and Modbus TCP
- DHCP (Dynamic Host Configuration Protocol)
- Access table to communicate with PC (HMI)



Specification

Item	XGL-ESHF(100BASE-FX)	
Transmission	Communication speed	100Mbps
	Method	Base band
	Max. Distance(Node to node)	2km
	Max. Segment length	-
	Max. node	50ea / segment
	Distance (Node to node)	0.5m
	Max. Protocol size	1,500 bytes
	Media access method	CSMA/CD
	Frame error check	CRC 32
Current consumption (A)	1.2	
Weight (g)	220g	

Fiber optic cable

Item	Description
Cable type	Twin strands of Multi mode fiber (MMF)
Connector	SC type
Diameter	62.5/125 μ m
Wave length	1,350nm
Diminution	Within 2dB/1,000m

System configuration

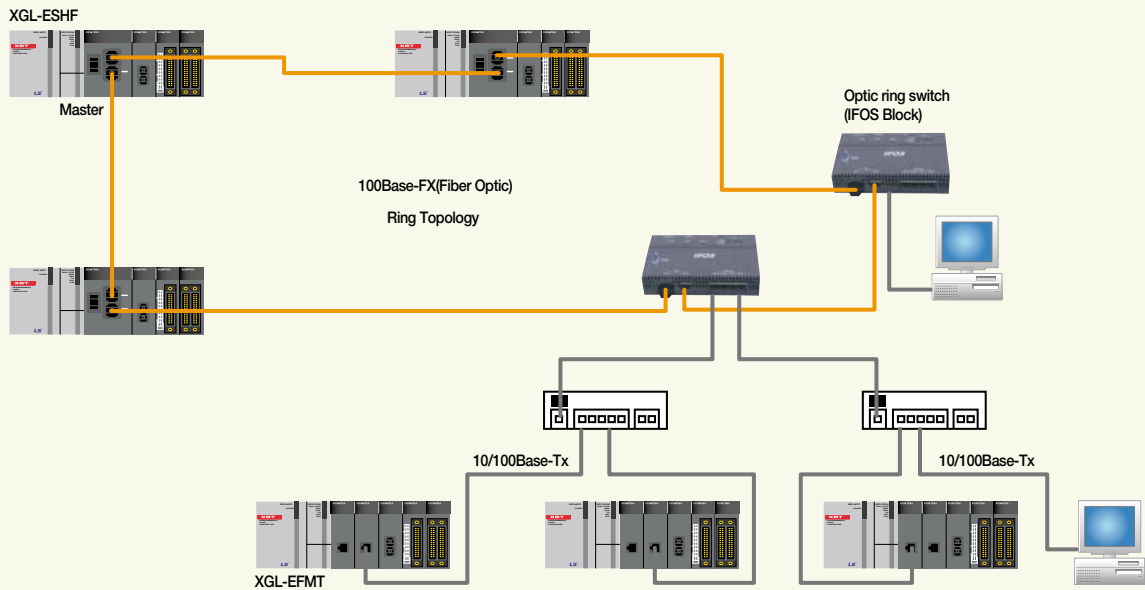

Network / XGT Ethernet switching hub

Features

- Rack type: No external power
- Reliability for industrial standard
- Auto Crossover
- FG (Frame Ground) for RJ-45 connector
 - Decreased communication error by shielded FTP/STP cable



Specification

Item		XGL-EH5T
Transmission	Communication speed	10/100Mbps
	Port type	10/100BASE-TX, TP cable, RJ-45 socket, 5ports
	Interface	Auto-Crossing, Auto-Nego., Auto-Polarity
	Distance	100m
	Diagnosis	LED (PWR, Link status, Data)
Current consumption (mA)		550
Weight (g)		90

System configuration

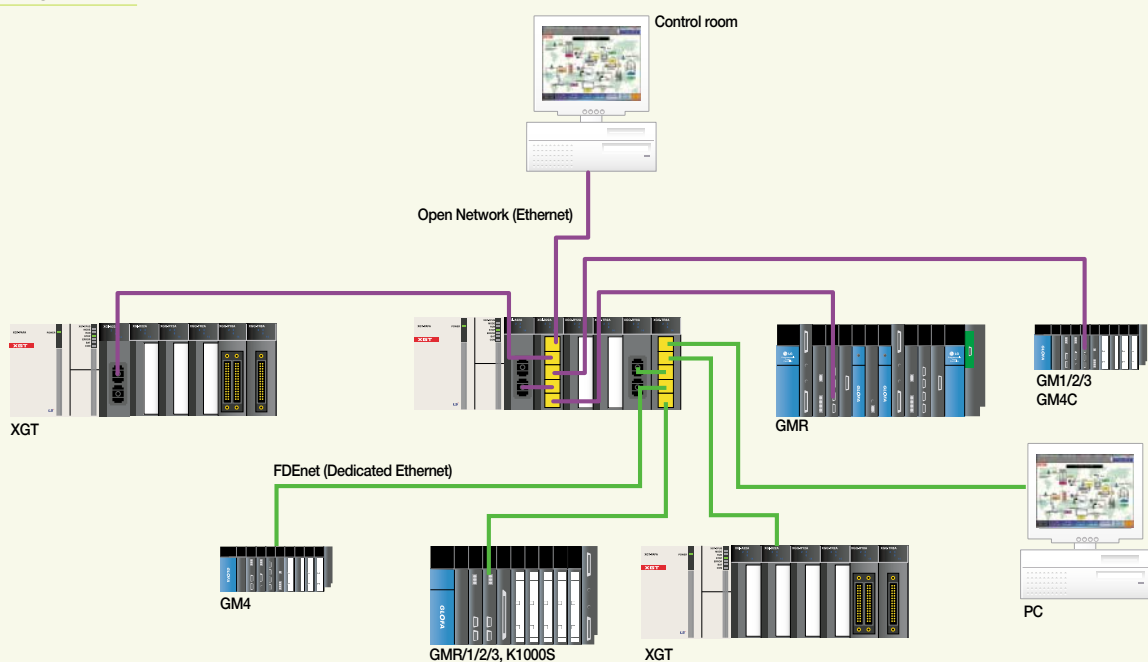

Network

Features

- Easy protocol editing and communication parameter setting: XG-PD
- Long-distance communication via modem connection
- Dedicated protocol for multi-drop configuration connectable up to 32 units
- RS-232C/422 communication port
- Flexible communication speed setting (300~115,200bps)
- Supporting full duplex and half duplex communication
- Max. 12 modules available in one CPU
- P2P service: User-defined communication and XGT/MODBUS master
- Various connection to MMI S/W (XGT, MODBUS RTU, MODBUS ASCII)
- Various diagnosis functions using XG-PD (I/O, link status, service status)
- Communication service information (Dedicated service, P2P service)
- Supporting simultaneously dedicated service in remote connection
- Communication without additional setting when replacing communication module

Various independent operation mode

- Operation mode
- Dedicated protocol mode (Simultaneous support)
- Program upload/download by XG5000 protocol (RS-232C)
Communication using LSIS dedicated protocol
- User-defined communication of P2P mode and XGT/MODBUS master



Communication via RS-232C/422

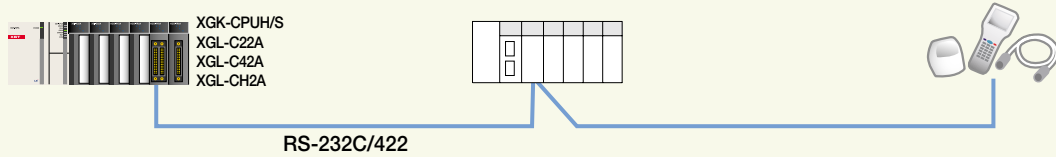

1: N and N: M connection (LSIS and other)

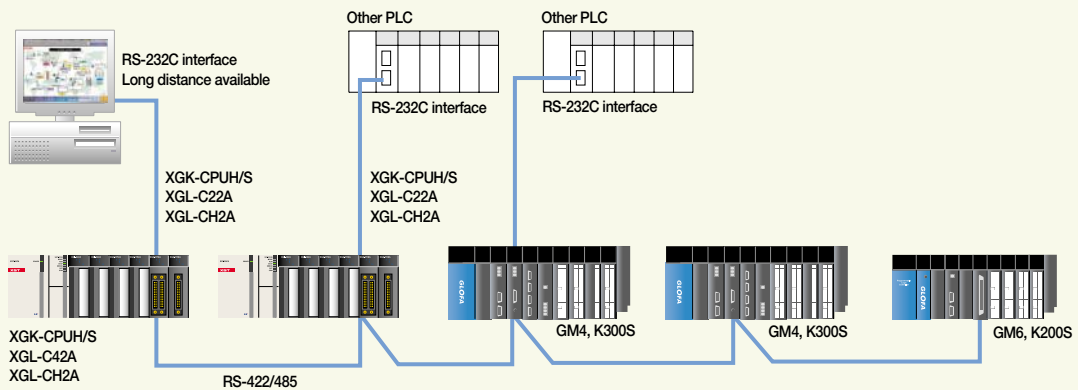

Specifications

Item	Specifications		
	XGL-C22A	XGL-C42A	XGL-CH2A
Interface	RS-232C, 2 channels	RS-422, 2 channels	RS-232C/RS-422, 1 channel
Modem connection	Remote communication with external devices via modem connection. Available for only RS-232C port.		
Communication mode	Dedicated mode	1: 1 or 1: N communication using LSI dedicated protocol	
	XG5000 mode	Program upload/download and remote control	
	P2P mode	Communication by protocol using XG-PD (Interface with other PLCs), XGT, MODBUS RTU/ASCII master communication	
Operation mode	Server (Slave)	Remote connection simultaneously using XGT/MODBUS Server, user-defined	
	Master	XGT, MODBUS RTU/ASCII master, user-defined	
Data type	Start Bit	1	
	Data Bit	7 or 8	
	Stop Bit	1 or 2	
	Parity	Even/Odd/None	
	Setting	Basic parameter setting with XG-PD	
Synchronization	Asynchronous		
Transmission speed (bps)	Selectable among 300/600/1,200/2,400/4,800/9,600/19,200/38,400/57,600/115,200 bps		
Station number setting	Up to 32 stations from 0 to 31 with XG-PD		
Transmission distance	RS-232C: Max. 15m (Extendible by using modem), RS-422/485: Max. 500m		
Modem communication	Available	Not available	Available via RS-232C
Network configuration	RS-232C 1: 1, RS-422 1: 1, 1: N, N: M		
Diagnosis function	Available through LED and XG-PD diagnosis service		
Max. number of installation	12		
Current consumption (mA)	310	300	310
Weight (Kg)	0.12	0.12	0.12

MODBUS

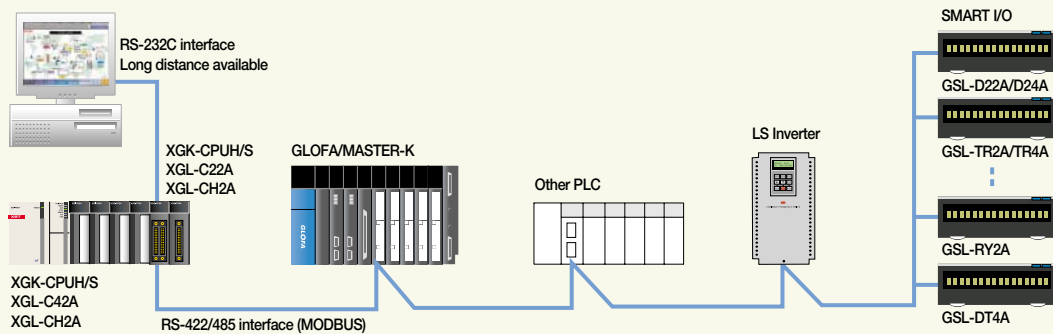

Cnet cable connection

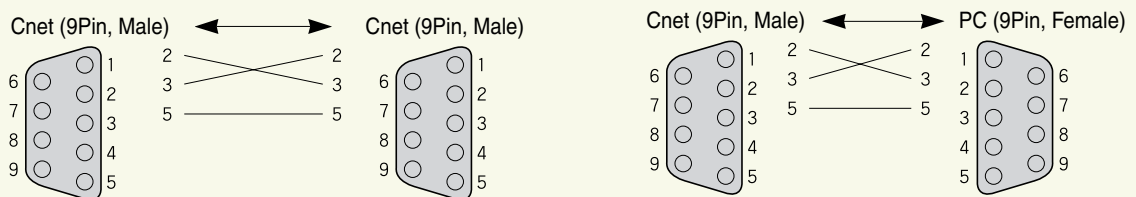

Features

- Communication speed: 1Mbps
- Communication distance: Max. 750m
- Available to use max. 6 repeaters (Up to 5.25Km)
- Network management using Auto-scan (Slave module information)
- Multi-drop network with smart I/O
- Network diagnosis and monitoring by XG-PD
- Max. 64 stations of slave modules controlled by one master module



System configuration

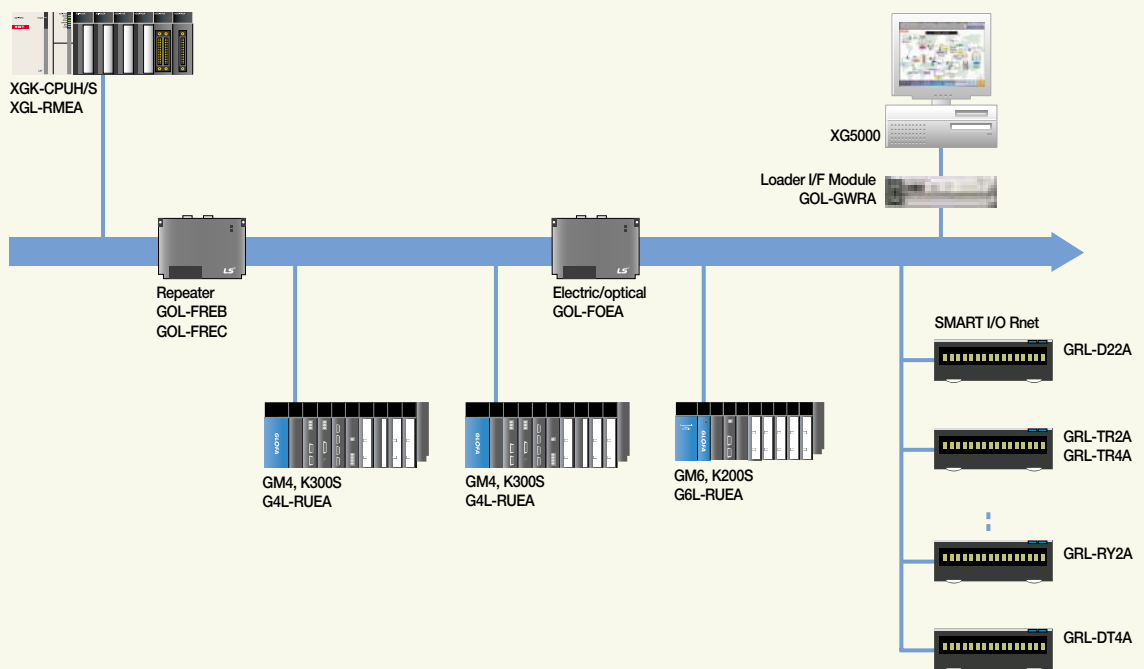

Specifications

Item	Specifications (XGL-RMEA)
Transmission speed	1Mbps
Encoding	Manchester Biphas-L
Transmission distance (Per segment)	Max. 750m
Transmission distance (When using repeater)	Max. 750m * (6 repeater + 1) = 5.25Km
Transmission cable	Twisted pair shield cable
Max. number of connection stations	Master + Slave = 64 stations (with repeater), 1 segment=32 stations (with master)
Max. size of protocol	256 bytes
Medium access method	Circulated Token Passing
Frame error check	CRC 16 check
Max. number of installation	12
Installation position	Main base or expansion base
Current consumption (mA)	410
Weight (Kg)	0.12

SMART I/O

- Reduction of wiring and real-time control of distributed I/O
- Various I/O module (16/32 points)



Network

Repeater specifications

Item	Specifications
Type	G0L-FREB: AC110V ~ AC220V, G0L-FREC: DC 24V
Communication speed	1Mbps
Transmission method	Twisted pair shield cable
Transmission distance	Max. 750m per repeater
Max. number of installation between stations	Max. 6 repeaters
Max. distance between stations	5.25Km (when 6 repeaters are installed)
Fault data reception	Error data transmission
Frame error check	CRC 16 check

Network cable and peripheral devices

Item	Specifications	Remarks
Twisted pair electric cable	LREV-AMESB, 2 × 1mm, 18AWG	LS cable
RF terminator	110Ω, 1/2 Watt	-

Features

- DeviceNet protocol
- Direct control of various I/O devices via Dnet system
- Max. 63 slave modules controlled by one master module
- Flexibility in network configuration: Multi-drop and T branch connection
- Connectable to other master module and various slave modules
- Providing 'Auto Network Scan' function and various information with configuration tool (SyCon)
- Communication using High-speed link parameter
- Connectable to various slave I/O including other module (Common I/O, Actuator, Switch, Optical switch, Valve, Inverter, A/D module, Position controller etc..)
- Automatic monitoring of slave modules in the network: Auto-scan (XG-PD)
- Easy expansion: up to 12 master modules
- Network setting by SyCon/XG-PD (Parameter setting, diagnosis and monitoring)



System configuration with LSIS products

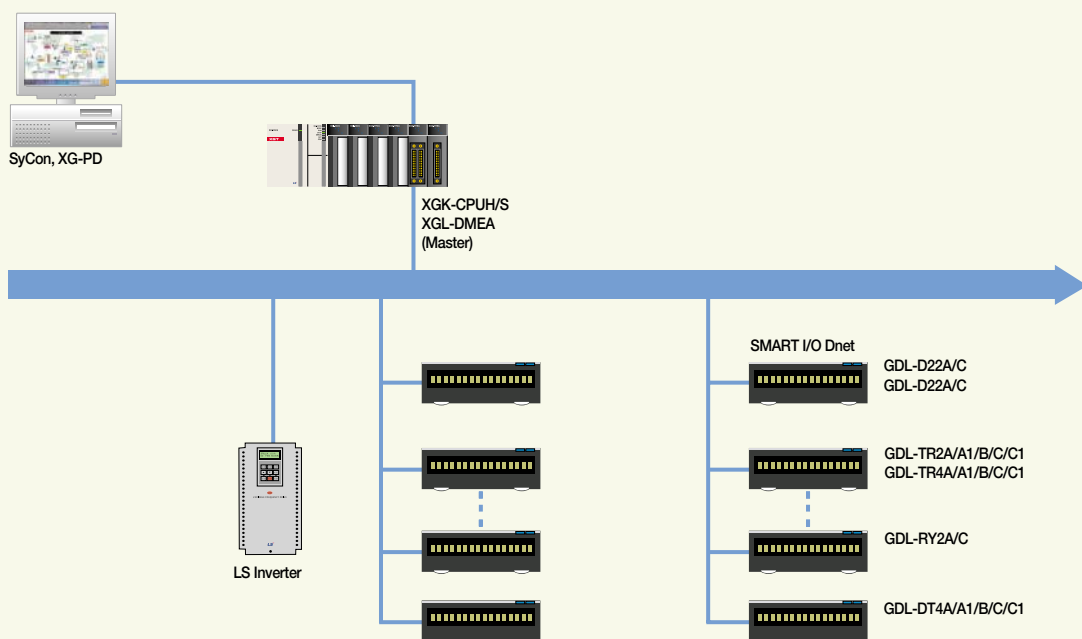

Specifications

Item	Specifications (XGL-DMEA)			
Module type	Master			
Transmission distance and speed	Trans. speed	Max. network length	Max. drop cable	Length of all drop cable
	500kbps	100m	6m	39m
	250kbps	250m	6m	78m
	125kbps	500m	6m	156m
Max. number of connection stations	64 stations (Master 1 + Slave 63)			
Max. number of node	Max. 64 MAC ID (Node address)			
Communication method	Bit Strobe, Poll, COS, Cyclic			
Diagnosis function	Duplicated station check Abnormal station detection/CRC error check/Scan List/Operation display (LED)			
Cable	Dnet dedicated cable: 5 (Signal: 2, power: 2, shield: 1)			
Max. number of installation	12			
Configuration tool	SyCon			
Configuration port	RS-232C Configuration Port			
Current consumption (mA)	440			
Weight (Kg)	0.11			

System configuration with other products

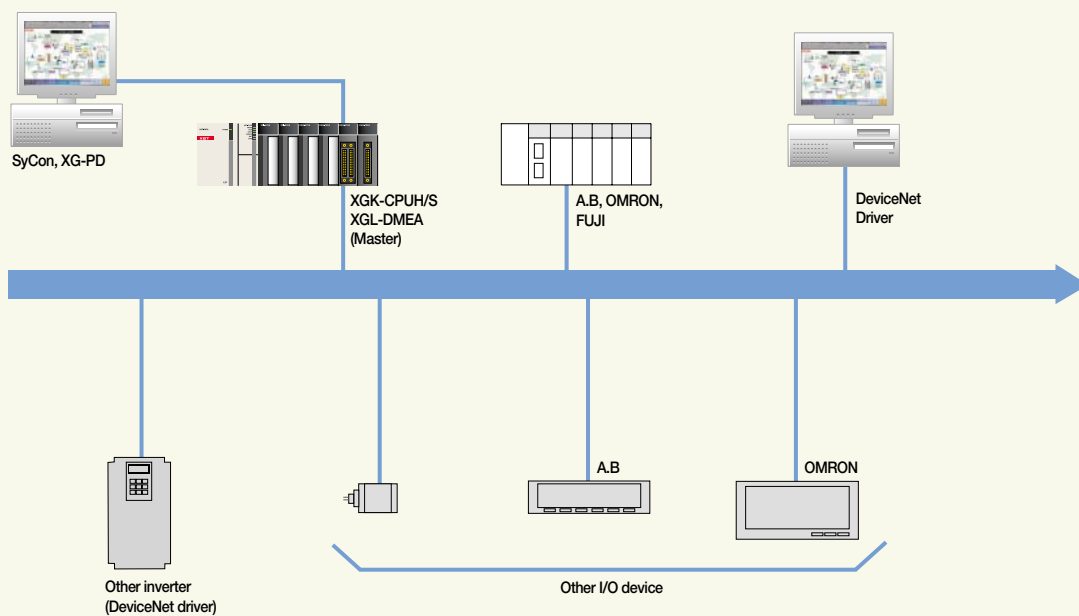

Features

- Profibus-DP protocol
- Proper to communicate among a master automation device and distributed slave I/O devices.
- Fast slave communication without application layer
- Transmission speed: 9.6Kbps ~ 12Mbps
- Transmission distance: Max. 1,200m
- Max. 126 slave stations available (32 stations per segment)
- Network setting using SyCon/XG-PD (Parameter setting, diagnosis and monitoring)
- I/O data of master station: 7kbytes
- Automatic monitoring of slave modules in the network: Auto-scan (XG-PD)
- Multi master
- Providing 'Auto Config' and various information with configuration tool (SyCon)



System configuration with LSIS products

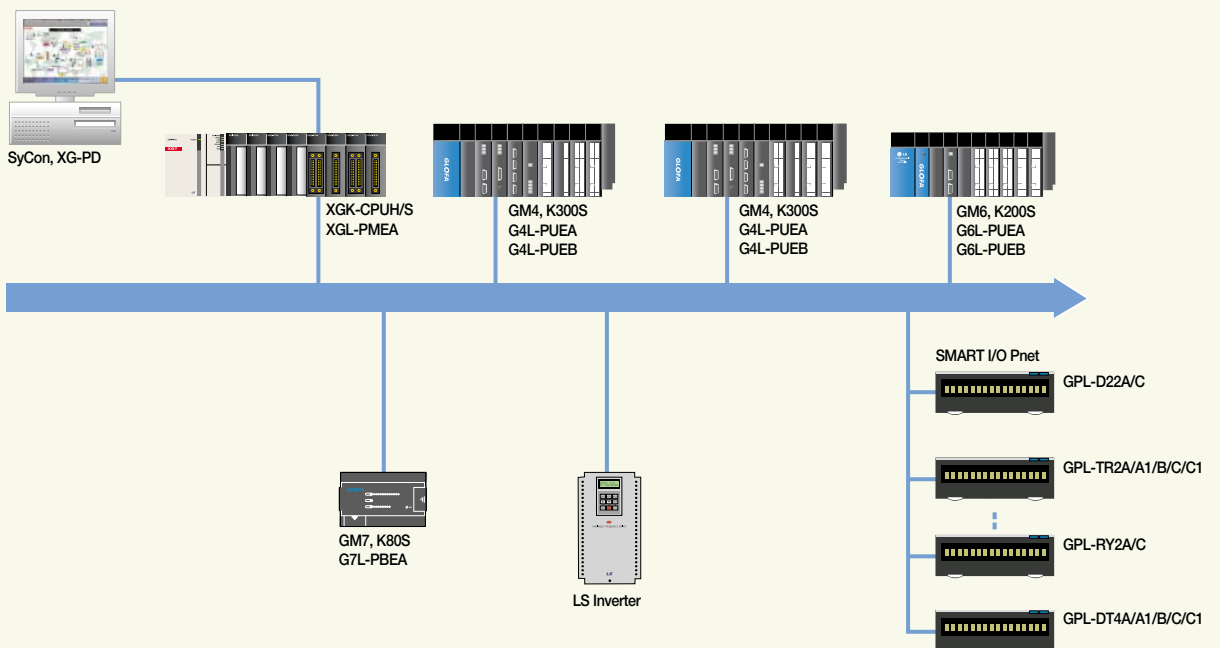

Specifications

Item		Specifications (XGL-PMEA)
Module type		Master
Network type		Profibus-DP
Standard		EN50170/DIN19245
Interface		RS-485 (Electric)
Media access		Token Passing & Poll
Topology		Bus
Modulation		NRZ
Cable		Shield Twisted Pair Cable
Transmission distance and speed	1,000m	9.6K-187Kbps
	400m	500Kbps
	200m	1.5Mbps
	100m	3M-12Mbps
Max. number of slave per network		126
Max. number of slave per segment		32
Max. I/O data		Input: 3584byte, Output: 3584byte
Max. number of communication points		7Kbytes
Communication parameter setting		XG-PD, SyCon
Max. number of installation		12
Configuration Tool		SyCon
Configuration Port		RS-232C Configuration Port
Current consumption (mA)		550
Weight (Kg)		0.11

System configuration with other products

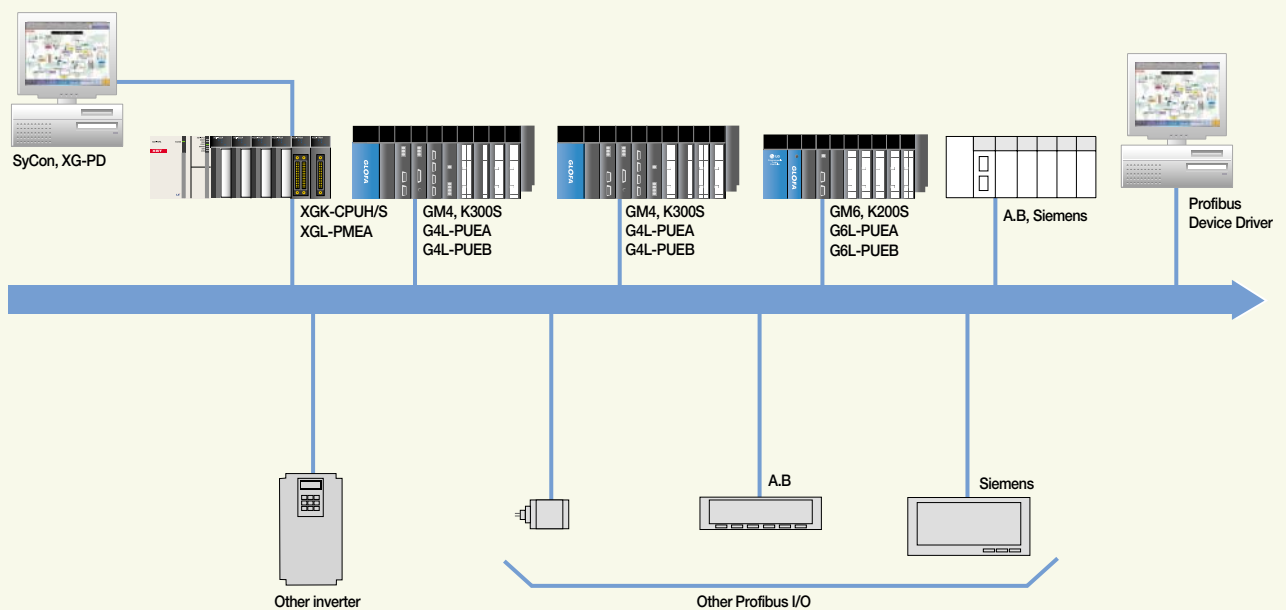

Communication among PLCs

This is a system configuration communicating between XGT PLCs by serial communication. In this case, PLC 1 is the master (Client) and other PLC should be slaves (Server). It is called Master/Slave communication. Master PLC is defined by comm. basic parameter and P2P setting. And slave PLC is defined by basic parameter and driver setting.

Configuration

PLC1 reads present value, C0000 of PLC2's up-counter and then saves it in M0200 of PLC1.

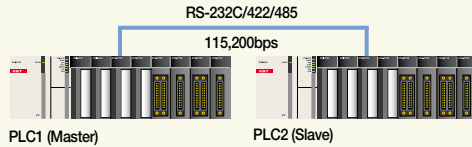

Data memory

PLC station	PLC memory	Setting Item
PLC 1	M0100	1. XG-PD parameter setting, 2. XG5000 programming
PLC 2	C0000	1. XG-PD parameter setting, 2. XG5000 programming

XG-PD setting

PLC 1 setting (Master)

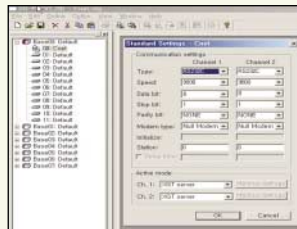

Communication basic parameter setting
Setting up station number, communication speed, etc. And setting up the operation mode as P2P



P2P channel setting
Setting up channel 01 as [XGT client]

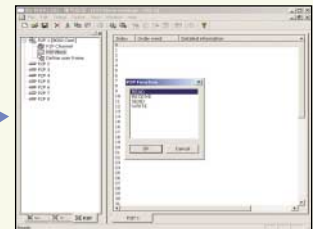

P2P setting
Setting up P2P block (READ)

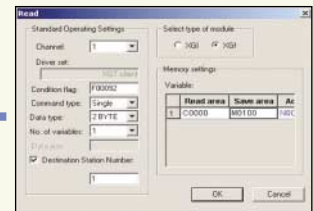

Communication data setting
Setting up Read area, Save area, etc.

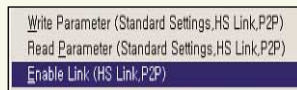

Enable Link
Enabling P2P for communication start



Parameter writing
Downloading parameters to PLC after online connection

PLC 2 setting (Slave)

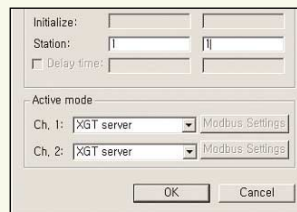

Communication parameter setting
Setting up station number and channel 01 mode as 1 and XGT server

* For basic parameter setting and SyCon setting/change, reset the module (Online reset).

XG5000 programming

PLC station 2 setting

Make up-counter program using CTU command

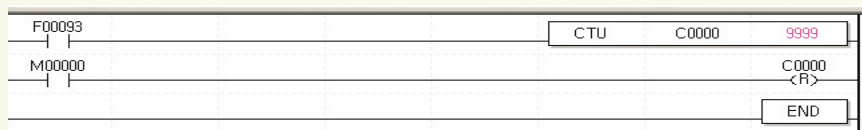

PLC station 1 setting

Check out the counter value of M0100 is transmitted.

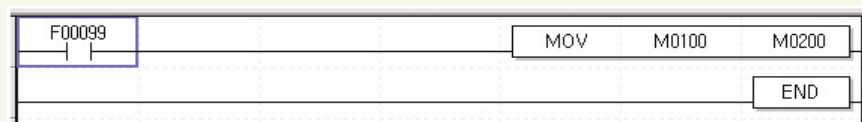

HMI communication configuration

This is a system configuration to monitor and control PLC (XGT) by XP (HMI). In this case, PLC is the slave (Server) and XP should be the master (Client). PLC is defined by comm. basic parameter and driver setting.

Configuration

Making On/Off touch tag for controlling M0001 of XGT

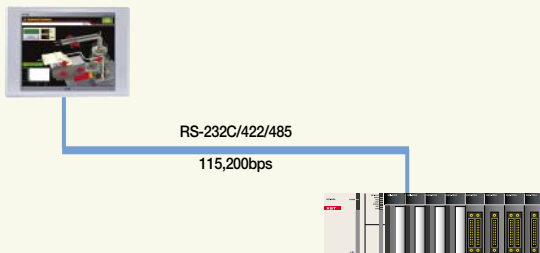

Data memory

PLC memory	Setting item	PMU
M000D1	1. XG-PD parameter setting	Using touch tag
	2. XG5000 programming	

XG-PD setting

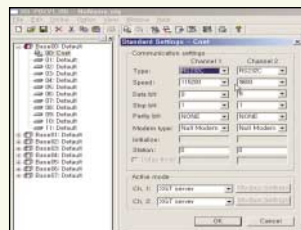

Basic communication parameter setting
Setting up station number, communication speed, etc. And setting up the operation mode as XGT server

Write Parameter (Standard Settings, HS Link, P2P)
Read Parameter (Standard Settings, HS Link, P2P)
Enable Link (HS Link, P2P)

Parameter writing
Downloading parameters to PLC after online connection



PMU setting
Setting up communication setting (speed, data, stop, parity, etc) same as XGT

* For basic parameter setting and SyCon setting/change, reset the module (Online reset).

XG5000 programming

Create program that P00010 is on right after M00001 is on.

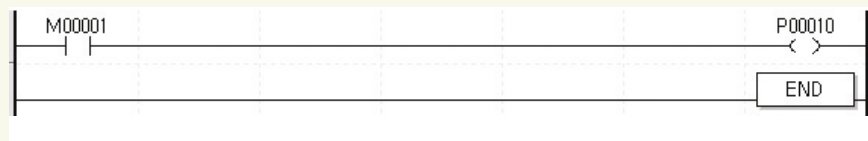

Network

Network / Communication example (Ethernet)

HMI communication configuration

This is a data communication system configuration among XGT PLCs via Ethernet network. In this case, communication is possible by HS link among PLCs. It just needs basic parameter setting and HS link item setting.

Configuration

Read the up-counter value C0000 of PLC1 and monitor it in GLOFAView.

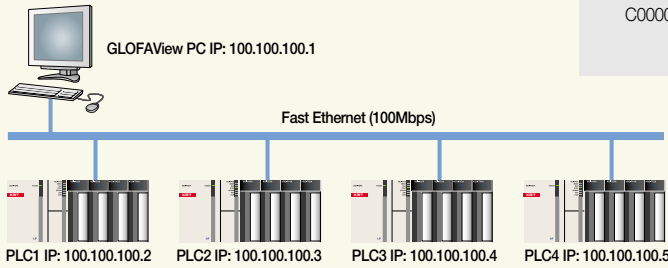

Data memory

PLC memory	Setting item	GLOFAView
C0000	1. XG-PD parameter setting	Using analog tag
	2. XG5000 programming	

XG-PD setting

PLC 1 setting (Master)

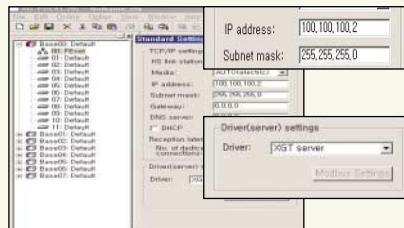

Basic communication parameter setting
Specifying IP address and Subnet mask of PLC as above

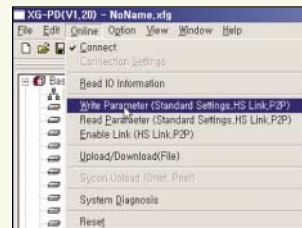

Parameter writing
Downloading parameters to PLC after online connection



Ping Test
Starting diagnosis after inputting IP address of PLC

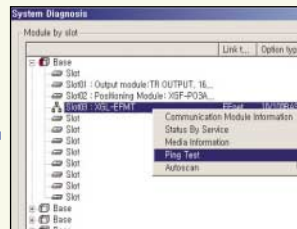

System Diagnosis
Selecting Ping Test

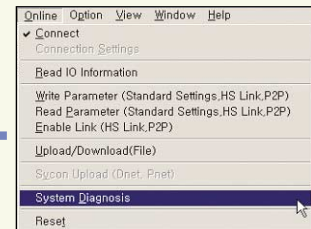

Communication test
Checking online and system diagnosis

* For basic parameter setting and SyCon setting/change, reset the module (Online reset).

XG5000 programming

Make the up-counter program using CTU command.

Check out if the counter value of CTU value is transmitted.

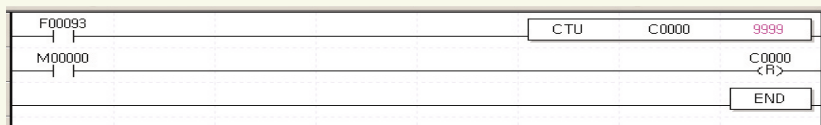

High-speed link communication

This is a configuration for XGT to communicate each other via Ethernet. It just needs communication basic parameter setting and High-speed link item setting.

Configuration

Read present value C0000 of PLC1 and transmit it to M0000 of PLC2.

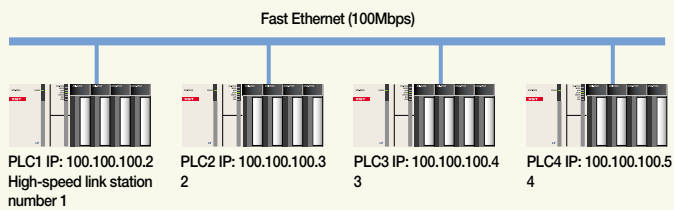

Data memory

PLC station	PLC memory	Setting Item
PLC 1	C0000	1. XG-PD parameter setting, 2. XG5000 programming
PLC 2	M0100	1. XG-PD parameter setting, 2. XG5000 programming

XG-PD setting

PLC station 1 setting

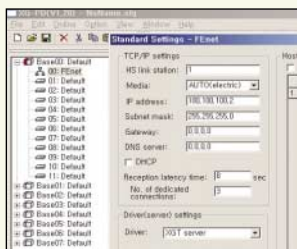

Basic communication parameter setting
Specifying HS link station, IP address and Subnet mask of PLC as above

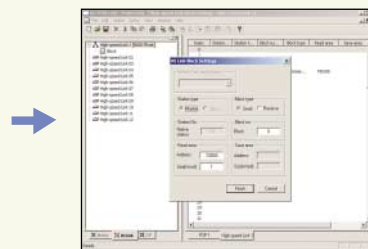

Communication data setting
Setting up communication data in HS link item as above



Parameter writing
Downloading parameters to PLC after online connection

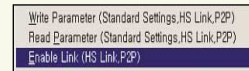

Enable Link
Enabling link for communication start

PLC station 2 setting

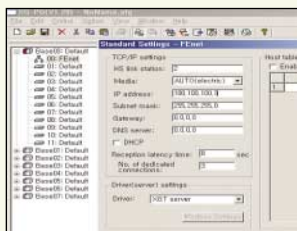

Basic communication parameter setting
Specifying HS link station, IP address and Subnet mask of PLC as above



Communication data setting
Setting up communication data in HS link item as above



Parameter writing
Downloading parameters to PLC after online connection



Enable Link
Enabling link for communication start

* For basic parameter setting and SyCon setting/change, reset the module (Online reset).

XG5000 programming

PLC1 setting

Make the up-counter program using CTU command

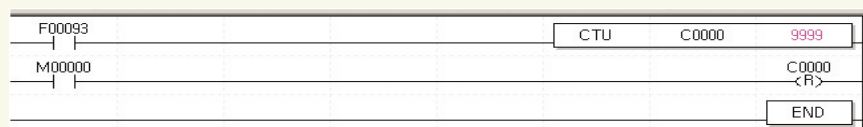

PLC2 setting

Check out if the counter value of M0100 is transmitted.

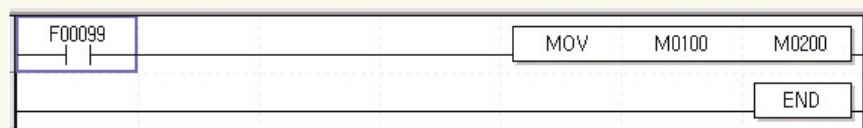

Remote I/O configuration

LSIS developed communication method is Rnet which is 'Distributed Control System' using Smart I/O. In this case, PLC is the master and the other Smart I/O are slaves. It just needs basic parameter setting for communication and High-speed link setting.

Configuration

PLC controls each Smart I/O (16-point).

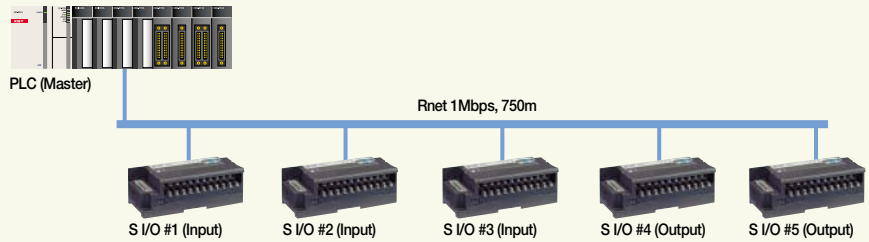

Data memory

Smart I/O #	Smart I/O address	PLC address	Setting item
1	P0000	P0010 (P00100~P0010F)	1. XG-PD parameter setting, 2. XG5000 programming
2	P0000	P0011 (P00110~P0011F)	
3	P0000	P0012 (P00120~P0012F)	
4	P0000	P0013 (P00130~P0013F)	
5	P0000	P0014 (P00140~P0014F)	

XG-PD setting

Communication data setting
Setting up type name, station number, address of each station's Smart I/O in HS link item as following example.

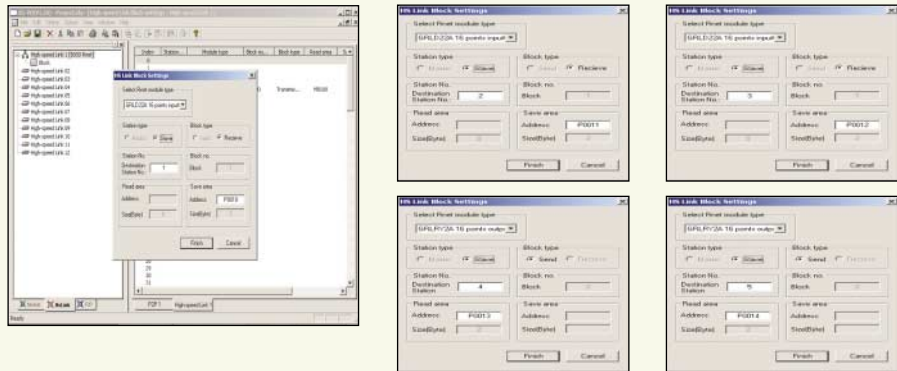

Station	Station Name	Block No.	Block Name	Start area	End area	Start in name
1	GRLD20A 16 points in...	1	Input	P0010	P001F	
2	GRLD20A 16 points in...	1	Input	P0011	P001E	
3	GRLD20A 16 points in...	1	Input	P0012	P001F	
4	GRLD20A 16 points in...	1	Output	P0013	P001E	
5	GRLD20A 16 points in...	1	Output	P0014	P001F	

HS link registration completed

Write Parameter (Standard Settings.HS Link.P2P)
Read Parameter (Standard Settings.HS Link.P2P)S
Enable Link (HS Link.P2P)

Parameter writing
Downloading parameters to PLC after online connection

Write Parameter (Standard Settings.HS Link.P2P)
Read Parameter (Standard Settings.HS Link.P2P)
Enable Link (HS Link.P2P)

Enable Link
Enabling link for communication start

* For basic parameter setting and SyCon setting/change, reset the module (Online reset).

XG5000 programming

Write a program using I/O address of Smart I/O.

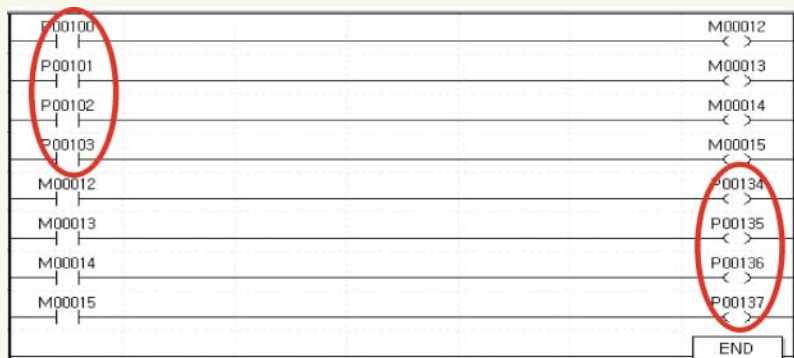

High-speed link communication among PLCs

XGT can create 'Distributed Control System' with Smart I/O, Inverter, pneumatic device via Profibus-DP. In this case, PLC is the master and the other devices such as Smart I/O are slaves. It just needs SyCon, basic parameter and High-speed link setting.

Configuration

PLC controls each Smart I/O (16-point).

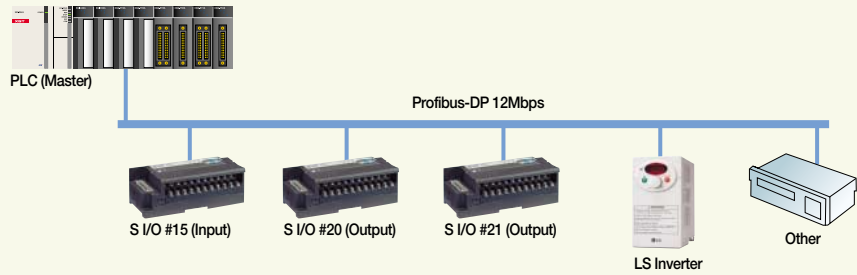

Data memory

Smart I/O #	Smart I/O address	PLC address	Setting item
15	P0000	P0010 (P00100~P0010F)	1. SyCon setting 2. XG-PD parameter setting, 3. XG5000 programming
20	P0000	P0011 (P00110~P0011F)	
21	P0000	P0012 (P00120~P0012F)	

XG-PD setting

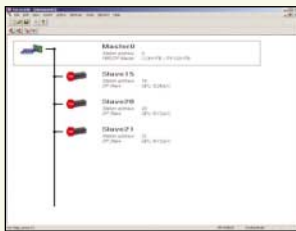

SyCon setting
For detailed setting instruction, refer to page 43 (SyCon setting)

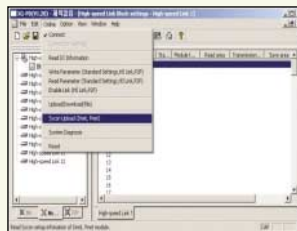

HS link setting
Uploading SyCon and setting up each Smart I/O station as following example

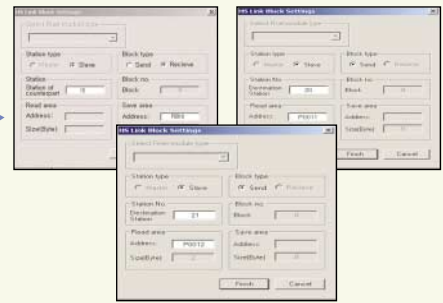

Parameter writing
Downloading parameters to PLC after online connection



Enable Link
Enabling link for communication start

* For basic parameter setting and SyCon setting/change, reset the module (Online reset).

XG5000 programming

Write a program using I/O address of Smart I/O Pnet

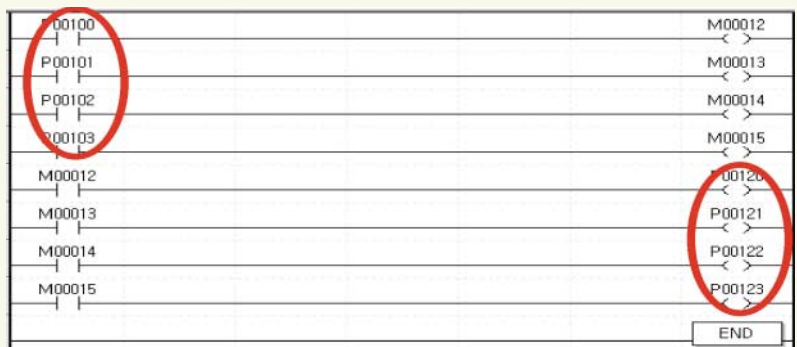

Network / Communication example (DeviceNet)

High-speed link communication between PLCs

XGT can create 'Distributed Control System' with Smart I/O, Inverter, pneumatic device via Dnet. In this case, PLC is the master and the other devices such as Smart I/O are Slaves. It just needs SyCon, basic parameter and High-speed link setting.

Configuration

PLC controls each Smart I/O (16 points).

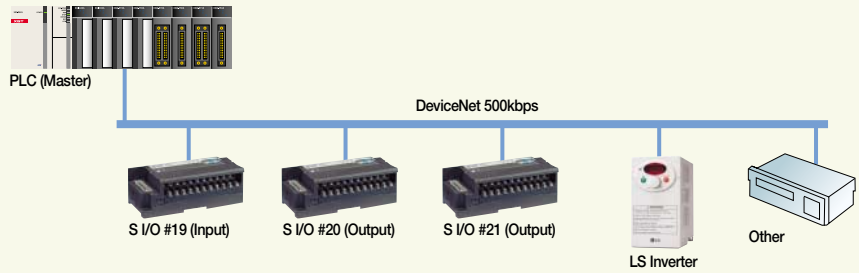

Data memory

Smart I/O #	Smart I/O address	PLC address	Setting item
19	P0000	P0010 (P00100~P0010F)	1. SyCon setting 2. XG-PD parameter setting, 3. XG5000 programming
20	P0000	P0011 (P00110~P0011F)	
21	P0001	P0012 (P00120~P0012F)	

XG-PD setting

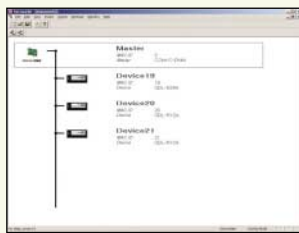

SyCon setting
For detailed setting instruction, refer to page 43 (SyCon setting)



HS link setting
Uploading SyCon and setting up each Smart I/O station as following example

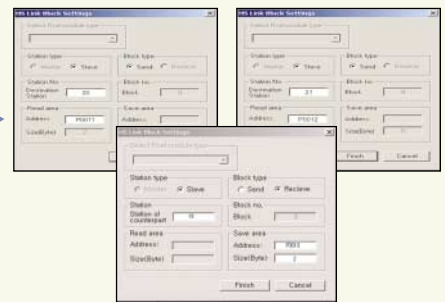

Parameter writing
Downloading parameters to PLC after online connection

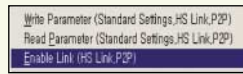

Enable Link
Enabling link for communication start

* For basic parameter setting and SyCon setting/change, reset the module (Online reset).

XG5000 programming

Write a program using I/O address of Smart I/O Dnet.

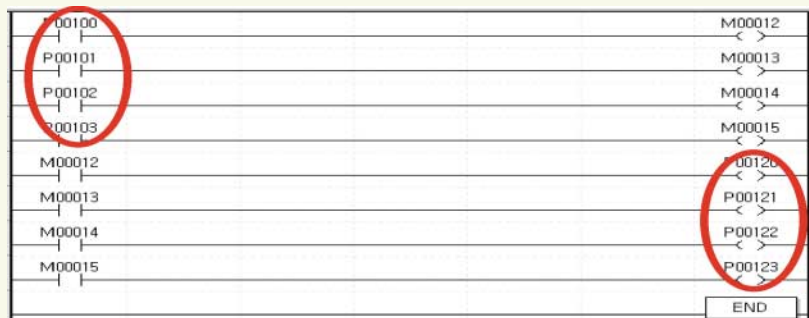

Network / Communication example (SyCon setting Profibus, DeviceNet)

SyCon is the dedicated software that help user set up the communication environment for Profibus-DP and DeviceNet more easily and conveniently.

Example of application

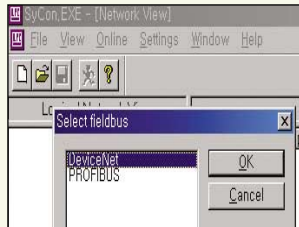

New file
Select fieldbus that is used.

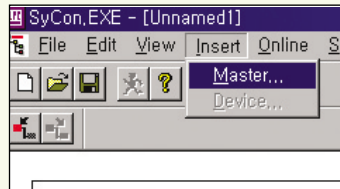

Basic communication parameter setting
Select [Master] in Insert menu.

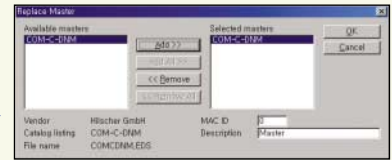

Master module setting
Select [COM-C-DNM] for DeviceNet.
Select [COM-C-DPM] for Profibus-DP.

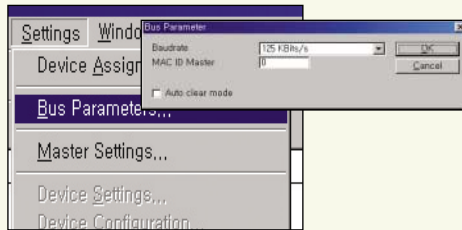

Bus parameter setting
Set up communication speed of master module.

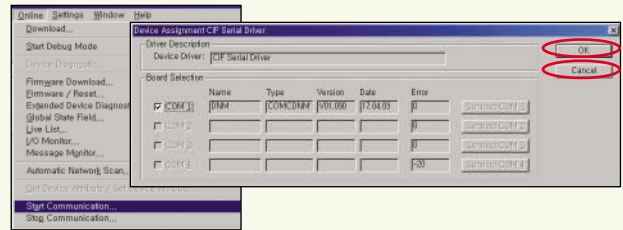

Master module setting
After clicking the port button, check the right check-box.

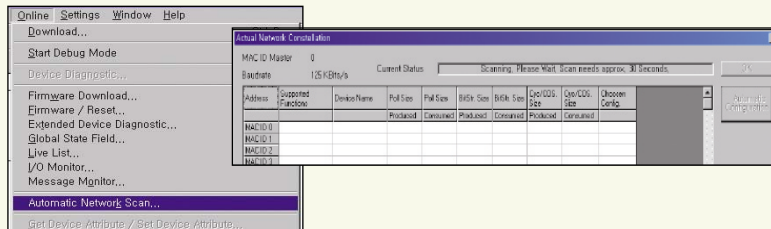

Automatic network scan of connected Smart I/O
Perform automatic network scan after station number setting and wiring with remote device such as Smart I/O.
At this time, all remote devices should be in normal connection (Power-On, etc).
After network scan is completed, press [Automatic Configuration] button and [OK] button.

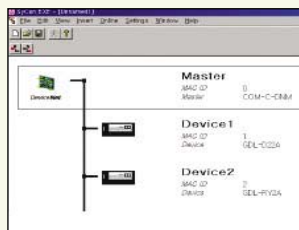

Network checking
Check normal network (remote) condition.

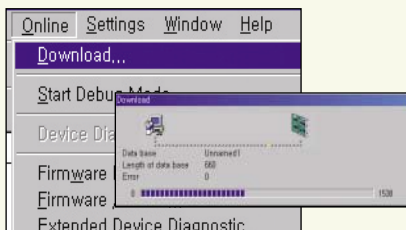

Parameter download

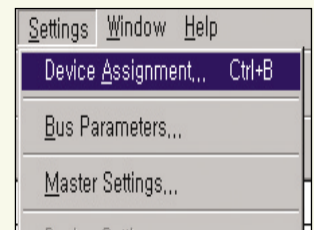

Disconnect
Disconnect the port in Device Assignment.

Network

Features

- Wiring reduction and real time control of distributed I/O
- Supporting Rnet, DeviceNet, Profibus-DP, MODBUS (RS-422/485)
- Various I/O (DC/TR/Relay) modules with the unit of 16/32 points



Digital I/O specifications

Item	Input		Output			Mixed module	
	DC (Sink/Source)		Transistor (Sink)		Relay	DC (Sink/Source)	Transistor (Sink)
No. of point	16	32	16	32	16	16	16
Rated input (Load voltage)	DC 24V		DC 24V		DC 24V/AC 110V/220V	DC 24V	DC 24V
Input current (Load current)	7mA		0.1A/2A, 0.5A/3A		2A/5A	7mA	0.1A/2A, 0.5A/3A
Response time	Off → On	3ms or less	3ms or less		3ms or less	3ms or less	3ms or less
	On → Off	3ms or less	3ms or less		3ms or less	3ms or less	3ms or less
Common	16 points/COM		16 points/COM		16 points/COM	16 points/COM	16 points/COM
Current consumption	200mA	300mA	280mA	380mA	550mA	350mA	
Network	Rnet	GRL-D22A	GRL-D24A	GRL-TR2A	GRL-TR4A	GRL-RY2A	GRL-DT4A
	Profibus-DP	GPL-D22A ●	GPL-D24A ●	GPL-TR2A ▲	GPL-TR4A ▲	GPL-RY2A ●	GPL-DT4A ▲
	DeviceNet	GDL-D22A ●	GDL-D24A ●	GDL-TR2A ▲	GDL-TR4A ▲	GDL-RY2A ●	GDL-DT4A ▲
	MODBUS	GSL-D22A	GSL-D24A	GSL-TR2A	GSL-TR4A	GSL-RY2A	GSL-DT4A

Note1) Specification stated in the table is specification of type A.
Refer to XGT user's manual.
● A, C ▲ A, A1, B, C, C1

A Sink, Rated current: 0.1A, terminal fixed type
A1 Sink, Rated current: 0.5A, terminal fixed type

B Source, Rated current: 0.5A, terminal fixed type
C Source, Rated current: 0.5A, terminal separated type
C1 Sink, Rated current: 0.5A terminal separated type

Analog I/O specifications

Item	GPL-AV8C	GPL-AC8C	Item	GPL-DV4C	GPL-DC4C
Input channels	8 channels		Output channels	4 channels	
Analog input	DC 1~5V, 0~5V, 0~10V, -10~+10V	0~20mA, 4~20mA, -20~20mA	Digital input	0~4000, 0~8000, -8000~8000	0~8000
Digital output	0~4000, 0~8000, -8000~8000	0~4000, -8000~8000	Analog output	DC 1~5V, 0~5V, 0~10V, -10~+10V	0~20mA, 4~20mA
Input impedance	1MΩ	250 Ω	Load impedance	1KΩ or more (0~5V or 1~5V) 2KΩ or more (0~10V or -10~10V)	500 Ω or less
Max. resolution	±15V 1.25mV	±30mA 2.5μA	Resolution	1.25mV	2.5μA
Accuracy	±0.3% (full scale, Ta=0~55°C)	±0.3% (full scale, Ta=23°C±5°C) ±0.4% (full scale, Ta=0~55°C)	Accuracy	±0.3% (full scale, Ta=0~55°C)	±0.3% (full scale, Ta=23°C±5°C) ±0.4% (full scale, Ta=0~55°C)
Conversion speed	10ms or less / 8 channel		Conversion speed	10ms or less / 4 channel	
Response period	10ms or less / 8 channels + Transmission period (ms)		Response period	10ms or less / 8 channels + Transmission period (ms)	
Insulation method	Analog input/output terminal with FG→Insulation Analog input/output terminal with Communication terminal→Insulation Analog input/output terminal with each channel→No insulation		Insulation method	Analog input/output terminal with FG→Insulation Analog input/output terminal with Communication terminal→Insulation Analog input/output terminal with each channel→No insulation	
External power supply	DC24V (21.6 ~ 26.4)		External power supply	DC24V (20.4 ~ 28.8)	
External current consumption	DC24V : 220mA		External current consumption	210mA	240mA
Weight (kg)	0.313	0.313	Weight (kg)	0.314	0.322

Communication specifications

Item	Rnet (Dedicate network for LSIS Smart I/O)	Profibus-DP	DeviceNet	MODBUS
Protocol	LSIS dedicated protocol (Fnet for Remote)	Profibus-DP (RS-485/EN50170)	DeviceNet (CAN)	MODBUS (RS-422/485)
Transmission speed	1Mbps	9.6kbps ~ 12Mbps	125/250/500Kbps	2.4Kbps ~ 38.4Kbps
Transmission distance	750m/segment	100m ~ 1.2Km	500/250/125m (Thin cable: 100m)	500m
Topology	Bus Token	Bus	Trunk & Drop	Bus
Transmission	Pass & Broadcast	Token Pass & Master/Slave (Poll)	CSMA/NBA (Poll, Cyclic, COS, BitStrobe)	Master/Slave (Poll)
No. of stations	32/segment (Input: 32, Output: 32)	32/segment, 99/network	64	32
Link capacity	2,048 points/master (64 stations × 32 points)	7Kbyte/master	2,048 points/master	64 points/station

Note1) Smart I/O supports Poll type currently, but is supposed to support Cyclic, COS and Strobe later on.

Network / SMART I/O (DeviceNet adapter)

Features

- Max. 63 stations
- Flexible connection via DeviceNet
- Utilize same I/O modules with XGB
 - Max. 512 I/O points
 - Max. 32 channels analog input/output



Specification

Items		Description		
Communication Specification		Poll, Bit-strobe, COS/Cyclic		
		Group 2 only slave		
		Auto baud rate		
Module's Type		Slave		
Max. Node Number (MAC ID)		64(0~63)		
Number of Expansion I/O Slots		8		
Max. DC I/O Data Size		Input:32bytes / Output:32bytes		
Max. Analog Channels		Input : 16Channels / Output : 16Channels		
Speed & Distance	Comm. Speed	125 kbps	250 kbps	500 kbps
	Distance	500 m	250 m	100 m
Input Power	System Power	DC 24V		
	Range	19.2V ~ 28.8V(11V operate)		
	Output Voltage/Current	5V(±20%) /1.5A		
Weight(g)		100		

* When I/O module is installed, check the current consumption (Max. Current: 1.5A)

System configuration

Items	Description	Max. I/O point	
Digital I/O	XBE-DC08A	DC24V input 8pt	256points
	XBE-DC16A	DC24V input 16pt	
	XBE-DC32A	DC24V input 32pt	
	XBE-RY08A	Relay output 8pt	
	XBE-RY16A	Relay output 16pt	
	XBE-TN08A	Tr output 8pt, Sink	
	XBE-TP08A	Tr output 8pt, Source	
	XBE-TN16A	Tr output 16pt, Sink	
	XBE-TP16A	Tr output 16pt, Source	
	XBE-TN32A	Tr output 32pt, Sink	
	XBE-TP32A	Tr output 32pt, Source	
	XBE-DN16A	DC24V input 8pt , Tr output 8pt	
Analog, Temperature	XBF-AD04A	Current/Voltage input 4Ch	16channels
	XBF-DC04A	Current output 4Ch	
	XBF-DV04A	Voltage output 4Ch	
	XBF-RD04A	RTD input 4Ch	
XBF-TC04S	TC input 4Ch		

* When Digital input and Analog input is used together or Digital output Analog output is used, configure the system within 32bytes
(Ex) If 4ch analog input is used, Digital input can be used max. 192points

Externals and inscriptions

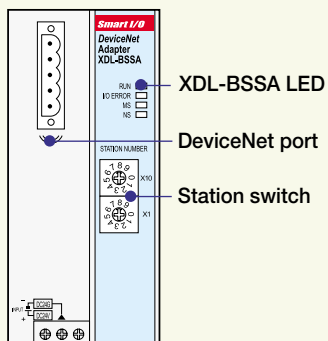

Item	LED status
RUN	ON : Normal
	OFF : Module error
I/O ERROR	ON : I/O module error
	OFF : Normal
MS	Green ON: Normal
	Green blink: Normal
	Red ON: Module error
	Green ON: Normal
NS	Green blink: Waiting
	Green off: Comm. stop
	Red ON: Network error
	Red blink: Disconnect

Dimension

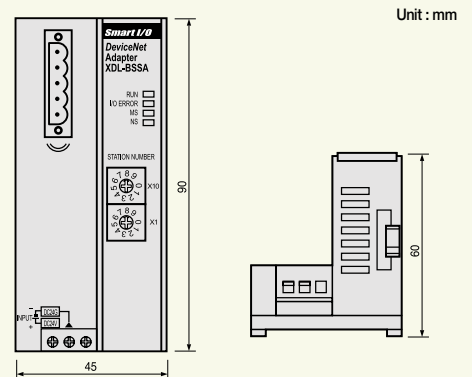

Features

- Max. 100 stations (32stations per segment)
- Flexible connection via Profibus
- Utilize same I/O modules with XGB
 - Max. 512 I/O points
 - Max. 32 channels analog input/output



Specification

Item	Performance Specification	
Transmission	Standard	EN50170 / DIN 19245
	Interface	RS-485(Electric)
	Media Access	Polling
	Topology	BUS
	Encoding Method	NRZ
	Interface	Sync mode , Freeze mode Auto baud rate
	Master/Slave	Slave
	Cable Type	Twisted Pair Shielded Cable
	Kbps	9.6 19.2 93.75 187.5 500
		Comm. m 1200 1200 1200 1000 400
	Distance	kpbs 1500 3000 6000 12000 -
		m 200 100 100 100 -
	Max. Node Number	100 (0 ~ 99)
	Number of Expansion I/O Slots	8
IO Data Size	64bytes (Input:32bytes /Output:32bytes)	
Number of Analog Channels	32Channels (Input : 16Channels/Output :16Channels)	
Input Power	System Power	Supply Voltage : DC 24Vdc 19.2 ~ 28.8Vdc
	Output Voltage/Current	5V(±20%) / 1.5A
Weight(g)	100	

* When I/O module is installed, check the current consumption (Max. Current: 1.5A)

System configuration

Item	Description	Max. I/O point	
Digital I/O	XBE-DC08A	DC24V input 8pt	256points
	XBE-DC16A	DC24V input 16pt	
	XBE-DC32A	DC24V input 32pt	
	XBE-RY08A	Relay output 8pt	
	XBE-RY16A	Relay output 16pt	
	XBE-TN08A	Tr output 8pt, Sink	
	XBE-TP08A	Tr output 8pt, Source	
	XBE-TN16A	Tr output 16pt, Sink	
	XBE-TP16A	Tr output 16pt, Source	
	XBE-TN32A	Tr output 32pt, Sink	
Analog, Temperature	XBE-TP32A	Tr output 32pt, Source	16channels
	XBE-DN16A	DC24V input 8pt , Tr output 8pt	
	XBF-AD04A	Current/Voltage input 4Ch	
	XBF-DC04A	Current output 4Ch	
	XBF-DV04A	Voltage output 4Ch	
	XBF-RD04A	RTD input 4Ch	
	XBF-TC04S	TC input 4Ch	

* When Digital input and Analog input is used together or Digital output Analog output is used, configure the system within 32bytes (Ex) If 4ch analog input is used, Digital input can be used max. 192points.

Externals and inscriptions

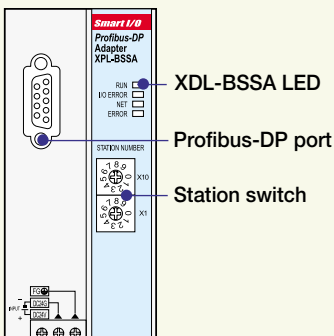

Item	LED status
RUN	ON : Normal
	Blink: Waiting or comm. error OFF : Module error
I/O ERROR	ON : I/O module error
	OFF : Normal
NET	ON : Data send/receive
	OFF : Disconnection
ERROR	ON : Comm. error
	OFF : Normal

Dimension

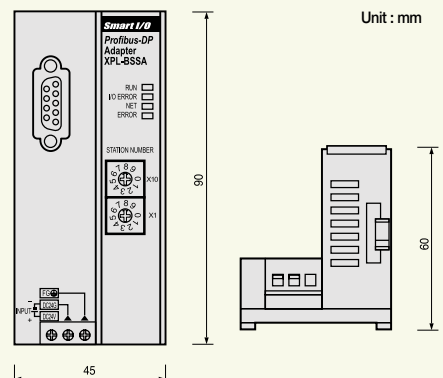

Network / SMART I/O (Rnet adapter)

Features

- Max. 63 stations
- LS dedicated protocol (Rnet)
- Utilize same I/O modules with XGB
 - Max. 512 I/O points
 - Max. 32 channels analog input/output



Specification

Item	Performance Specification	
Transmission	Tran. Rate	1Mbps
	Transmission Path	Bus type
	Method	750m
	Max. Cable Length	5 pin connector
	Connector type	Twisted Pair Shielded Cable
	Cable type	32(non-used repeater),
	No. of Station	64(used repeater)
	(Included Master)	512(Input : 256, Output: 256)
	Max. Digital I/O points	96
	Max. Analog I/O points	Digital I/O 8
	Number of I/O Slots	Analog I/O 4
	Selection of Latch/Clear	handling of mode change switch
Rated Voltage/current	DC24V/0.55A	
Weight (g)	100	

* When I/O module is installed, check the current consumption (Max. Current: 1.5A)

System configuration

Item	Description	Max. I/O point	
Digital I/O	XBE-DC08A	DC24V input 8pt	256points
	XBE-DC16A	DC24V input 16pt	
	XBE-DC32A	DC24V input 32pt	
	XBE-RY08A	Relay output 8pt	
	XBE-RY16A	Relay output 16pt	
	XBE-TN08A	Tr output 8pt, Sink	
	XBE-TP08A	Tr output 8pt, Source	
	XBE-TN16A	Tr output 16pt, Sink	
	XBE-TP16A	Tr output 16pt, Source	
	XBE-TN32A	Tr output 32pt, Sink	
	XBE-TP32A	Tr output 32pt, Source	
	XBE-DN16A	DC24V input 8pt, Tr output 8pt	
Analog, Temperature	XBF-AD04A	Current/Voltage input 4Ch	16channels
	XBF-DC04A	Current output 4Ch	
	XBF-DV04A	Voltage output 4Ch	
	XBF-RD04A	RTD input 4Ch	
	XBF-TC04S	TC input 4Ch	

* When Digital input and Analog input is used together or Digital output Analog output is used, configure the system within 32bytes
(Ex) If 4ch analog input is used, Digital input can be used max. 192points.

Externals and inscriptions

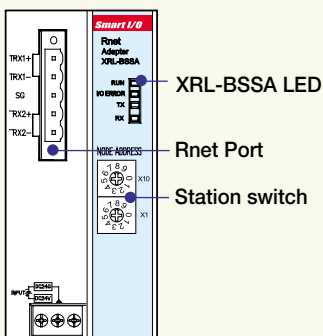

Item	LED status
RUN	ON : Normal
	OFF : Module error
I/O ERROR	ON : I/O module error
	OFF : Normal
TX	Data send
RX	Data receive

Dimension

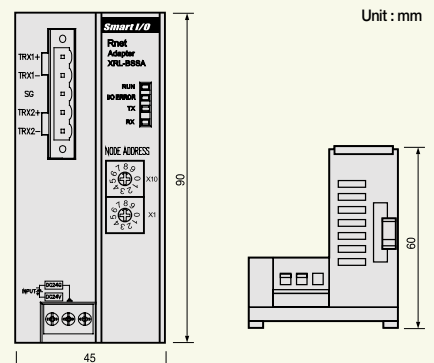

Smart I/O Rnet system

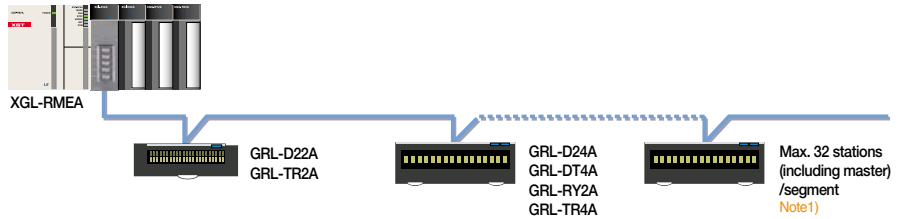

Smart I/O MODBUS system

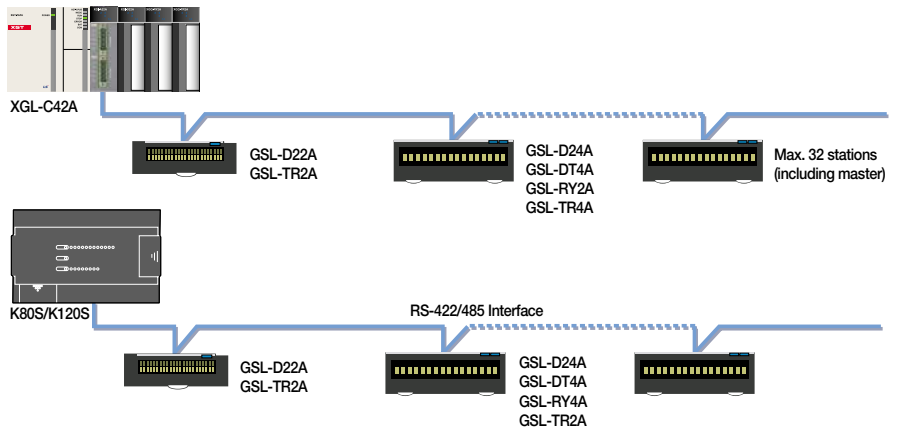

Smart I/O Profibus-DP system

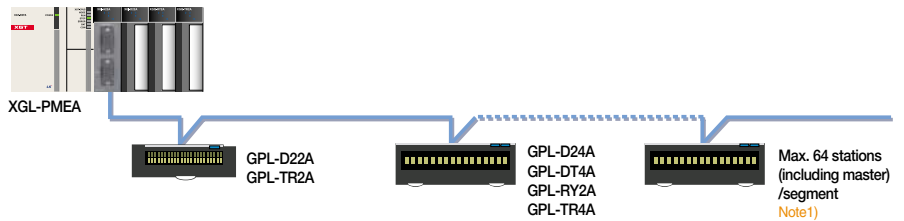

Smart I/O DeviceNet system

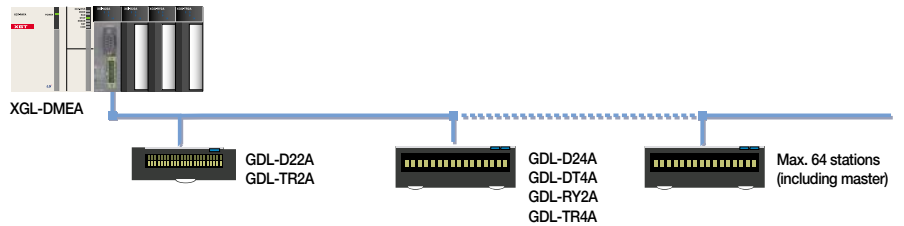

Note1) Segment: Communication section that does not use repeater or second master.

Dimensions

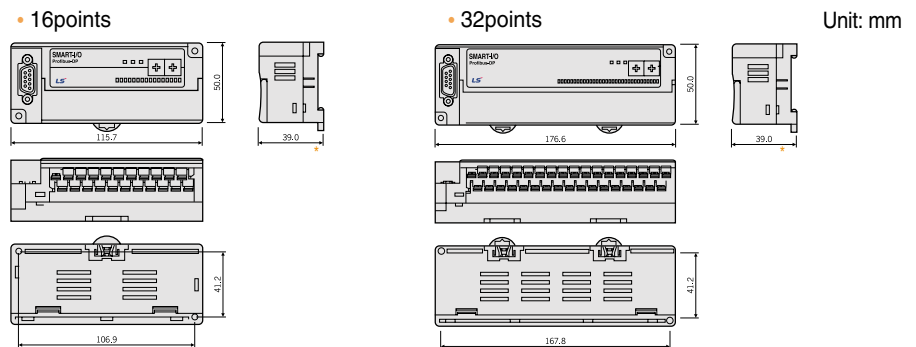

* GxL-RY2 (16-point relay output) module follows the dimension of 32-point module.
* The length of C type Smart I/O is 47.5mm



Special

XGT series offer diverse special modules such as analog, HSC, and positioning to satisfy complicated industrial needs

Special





Revolution of easy to use ...XGT Special module

Fast processing of parameter and data of special module

- Continually refreshing operation data of special module by CPU module
- Including contact points such as conversion data of AD/DA module and command of HSC & positioning module

Easy-to-use (Easy operation parameter setting and data monitoring)

- Convenient parameter setting available through XG5000
- Providing useful functions that can monitor and test operation data and contact points through XG5000

Simple maintenance (Changing online module)

- Without turning off and holding CPU, users can change special module with ease.

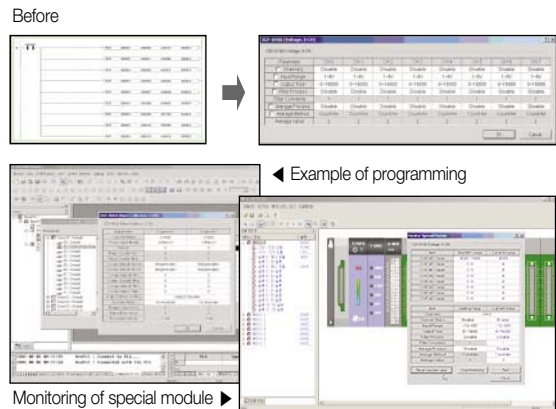

Analog input module

XGF-AV8A	8 channels, voltage input
XGF-AC8A	8 channels, current input
XGF-AD4S	4 channels, voltage/current input
XGF-AD8A	8 channels, voltage/current input
XGF-AD16A	16 channels, voltage/current input

Analog output module

XGF-DV4A	4 channels, voltage output
XGF-DV4S	4 channels, voltage output, insulation
XGF-DC4A	4 channels, current output
XGF-DC4S	4 channels, current output, insulation
XGF-DV8A	8 channels, voltage output
XGF-DC8A	8 channels, current output

Temperature input module

XGF-TC4S	4 channels, thermocouple input, Insulation
XGF-RD4A	4 channels, RTD input
XGF-RD4S	4 channels, RTD input, Insulation

High-speed counter module

XGF-HO2A	2 channels, Open collector
XGF-HD2A	2 channels, Line driver

Positioning module

XGF-PO(1/2/3)A	1/2/3-axis, Open collector
XGF-PD(1/2/3)A	1/2/3-axis, Line Driver

Temperature controller

XGF-TC4UD	4 channels input: voltage/current/TC/RTD
	8 channels output: current/TR

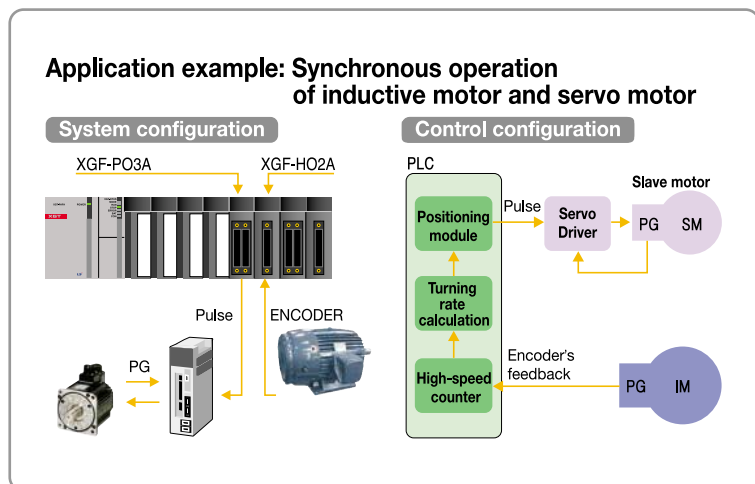
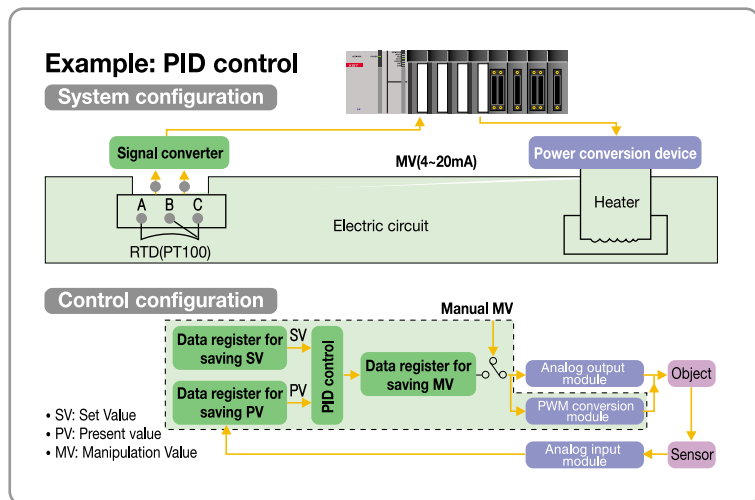

Special

Special module / Analog input module



Features

- Fast conversion processing
- High resolution
- Setting and monitoring the special module parameter through XG5000
- Supporting 4 types of digital output data format

Specifications

Item	XGF-AV8A (Voltage input)	XGF-AC8A (Current input)	XGF-AD4S (Voltage/Current input)							
No. of input channel	8 channels		4 channels							
Analog input	DC 1~5V, 0~5V, 0~10V, -10~10V	DC 4~20mA, 0~20mA	DC 1~5V, 0~5V, 0~10V, -10~10V DC 4~20mA, 0~20mA							
	Selection of input range in program or S/W package (Available to be set per channel)									
Digital output	XGF-AV8A	Analog input		1~5V	0~5V	0~10V	-10~10V			
		Digital output	Unsigned value		0~16,000					
			Signed value		-8000~8,000					
			Precise value		1,000~5,000	0~5,000	0~10,000	-10,000~10,000		
	Percentile value		0~10,000							
	XGF-AC8A	Analog input		4~20mA		0~20mA				
		Digital output	Unsigned value		0~16,000					
			Signed value		-8,000~8,000					
			Precise value		4,000~20,000		0~20,000			
	Percentile value		0~10,000							
	XGF-AD4S	Analog input		1~5V	0~5V	0~10V	-10~10V	4~20mA	0~20mA	
		Digital output	Signed value		-32,000~32,000					
Precise value			1,000~5,000	0~5,000	0~10,000	-10,000~10,000	4,000~20,000	0~20,000		
Percentile value			0~10,000							
Resolution	1/16,000		1/64,000							
	1~5V	0.250mV	4~20mA	1.0μA	1~5V	62.5μV	4~20mA	250nA		
	0~5V	0.3125mV			0~5V	78.1μV				
	0~10V	0.625mV	0~20mA	1.25μA	0~10V	156.3μV	0~20mA	312.5nA		
Accuracy	±0.2% or less (Ambient temperature 25°C)				±0.05% or less (Ambient temperature 25°C)					
	±0.3% or less (Range of operation temperature)				Temp. coefficient ±16.7ppm/°C(Range of operation temperature)					
Conversion speed	250μs/channel									
Max. absolute input	15V	±30mA		Voltage: ±15V, Current: ±30mA						
Insulation method	Photo-coupler Insulation between input terminal and power supply				Insulation between channels					
	No insulation between channels									
Connection terminal	18 points									
No. of occupied	Fixed type (Setting in basic parameter): 64 points									
I/O points	Variable type (Dissolving in basic parameter): 16 points									
Current consumption	420mA				610mA					
Weight (Kg)	0.14									

Configuration

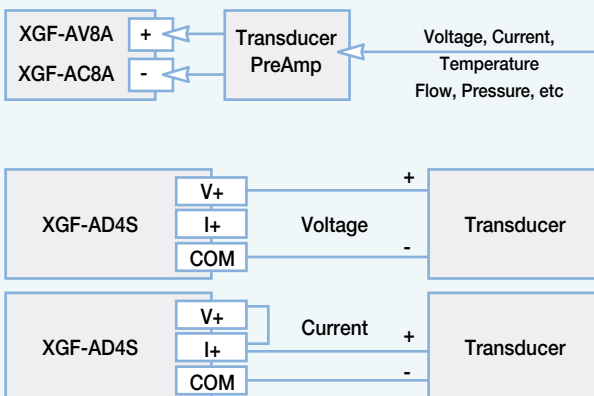

A/D conversion characteristics

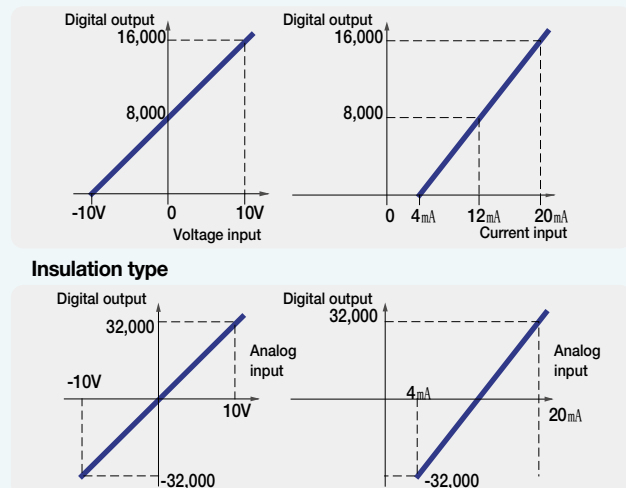

Features

- Fast conversion processing
- High resolution
- Setting and monitoring the special module parameter through XG5000
- Supporting 4 types of digital output data format



Specifications

Item	XGF-AD16A				XGF-AD8A		
No. of input channel	16 channels				8 channels		
Analog input	Voltage input						
	DC 1~5V, DC 0~5V, DC 0~10V, DC -10~10V (Input resistance: 1 MΩ)						
	Current input						
	DC4~20mA, DC 0~20mA (Input resistance: 250 Ω)						
Input selection	Dip switch						
Range selection	Selection of input range in the program or S/W package (Available to set per each channel)						
Digital output	Voltage input				Current input		
	Input type	DC 1~5V	DC 0~5V	DC 0~10V	DC -10~10V	DC 4~20mA	DC 0~20mA
	Unsigned value	0~16,000					
	Signed value	-8,000~8,000					
	Precise value	0~10,000					
	Percentile value	1,000~5,000	0~5,000	0~10,000	-10,000~10,000	4,000~20,000	0~20,000
	Resolution(1/16000)	0.2500mV	0.3215mV	0.6250mV	1.250mV	1.00μA	1.25μA
	Range selection	Selection of input type by program or parameter (Available to be set per each channel)					
Resolution	±0.2% or less (Ambient temperature 25°C), ±0.3% or less (Range of operation temperature)						
Max. absolute input	±15V				±30mA		
Conversion speed	500μs/channels				250μs/channels		
Insulation method	Photo-coupler insulation between terminal and power supply						
Terminal	32 points				18 points		
No. of occupied I/O points (XGK)	Fixed type (Setting in basic parameter): 64 points				Variable type (Dissolving in basic parameter): 16 points		
Current consumption	DC 5V : 420mA						
Wight	140g						

Configuration

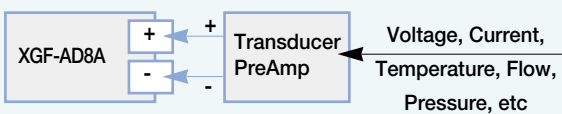

A/D conversion characteristics

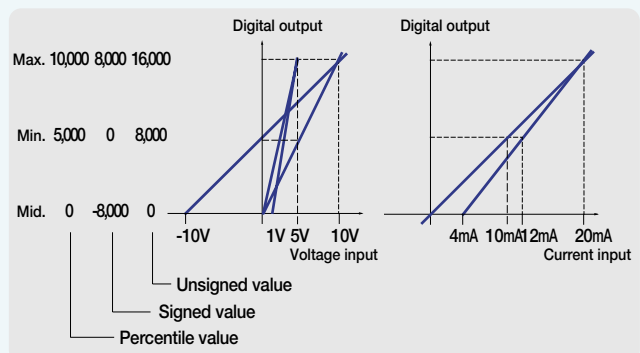

Special module / Analog input module (Example)

This is a simple example to start Analog input module setting. For more details, refer to user's manual.

System configuration

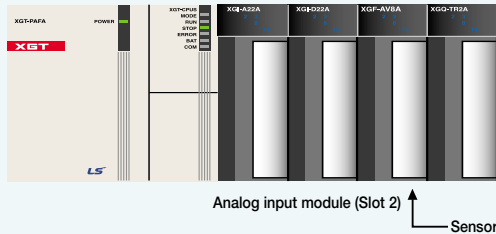

Wiring

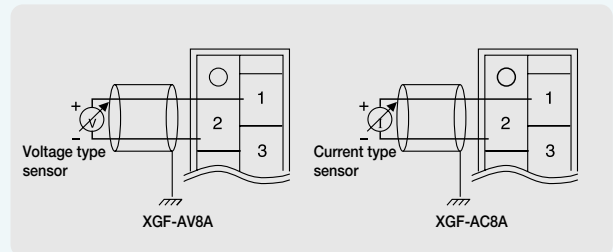

Parameter setting

In the parameter setting box, select slot and analog module that you want to use.
(This example shows to select '0' channel of voltage input type.)

XGF-AV8A (Voltage, 8-CH)

Parameter	CH 0
<input type="checkbox"/> Channels	Disable
<input type="checkbox"/> Input Range	1~5V
<input type="checkbox"/> Output Type	0~16000
<input type="checkbox"/> Filter Process	Disable
Filter Constants	1
<input type="checkbox"/> Average Process	Disable
<input type="checkbox"/> Average Method	Count-Avr
Average Value	2

Press the <Details> button at lower end of parameter setting box after selecting the module.

You need to fill out each item suitable for your system.

Programming

Create a program for A/D conversion (0~10V to 0~16,000).

Special devices for programming

Refer to user's manual for more details.

U02.0.0: Error

U02.11.0: Requesting error-clear

U02.02: Memory of channel A/D value

Uxy.aa.bb
 x: Base number
 y: Slot number
 aa,bb: Refer to user's manual.

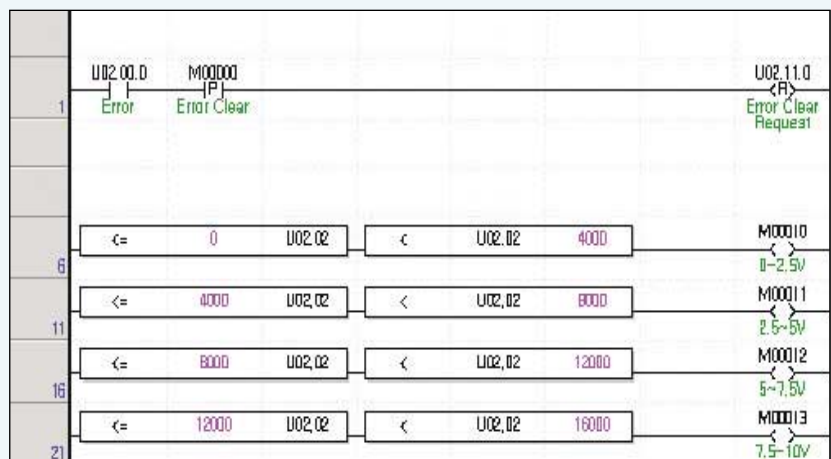

Features

- Fast conversion processing
- High resolution
- Setting and monitoring the special module parameter through XG5000
- Supporting 4 types of digital input data format



Specifications

Item	XGF-DV4A, XGF-DV8A, XGF-DV4S (Voltage output type)			XGF-DC4A, XGF-DC8A, XGF-DC4S (Current output type)				
No. of output channel	XGF-DV4A/4S, XGF-DC4A/4S : 4 channels / XGF-DV8A, XGF-DC8A : 8 channels							
Analog output range	DC 1~5V, 0~5V			DC 4~20mA				
	DC 0~10V, -10~10V			DC 0~20mA				
	Selection of input range in the program or S/W package (Available to set per each channel)							
Digital input range	Analog output	Voltage type		1~5V	0~5V	0~10V	-10~10V	
		Digital input	Unsigned value		0~16,000			
			Signed value		-8,000~8,000			
			Precise value		1,000~5,000	0~5,000	0~10,000	-10,000~10,000
	Percentile value		0~10,000					
	Analog output	Current type		4~20mA		0~20mA		
		Digital input	Unsigned value		0~16,000			
			Signed value		-8,000~8,000			
			Precise value		4,000~20,000		0~20,000	
			Percentile value		0~10,000			
16-bit binary value: selection of input type by program or parameter (Available to be set per each channel)								
Max. resolution	1/16,000 (Per each input range)							
	1~5V	0.250mV	4~20mA		1.0μA			
	0~5V	0.3125mV						
	0~10V	0.625mV	0~20mA		1.25μA			
Accuracy	XGF-DV4A/8A, DC4A/8A : ±0.2% or less (Ambient temperature 25°C), ±0.3% or less (Range of operation temperature)							
	XGF-DV4S/DC4S : ±0.1% or less (Ambient temperature 25°C), temp coefficient: ±80ppm/°C							
Conversion speed	250μs/channel							
Max. absolute output	±15V			±24mA				
Insulation method	Photo-coupler insulation between terminal and power supply							
	XGF-DV4A/8A, XGF-DC4A/8A: No insulation between channels XGF-DV4S, XGF-DC4S (Insulation type): Insulation between channels							
Connection terminal	18 point terminal							
No. of occupied points	Fixed type (Setting in basic parameter): assign 64 points							
	Variable type (Dissolving in basic parameter): assign 16 points							
Current consumption (mA)		DV4A	DV8A	DV4S	DC4A	DC8A	DC4S	
	Internal	190	190	200	190	190	200	
External	140	180	150	210	300	220		
Weight (Kg)	0.15							

Output wiring

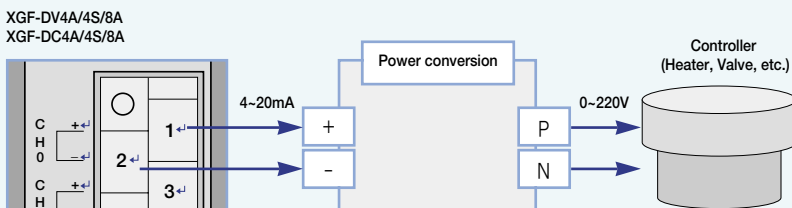

I/O conversion characteristics

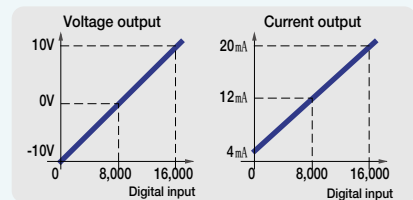

Insulation type

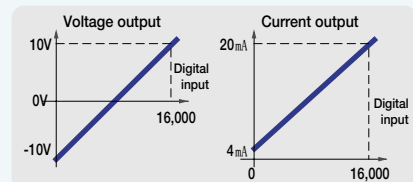

Special module / Analog output module (Example)

This is a simple example to start Analog output module setting. For more details, refer to user's manual.

System configuration

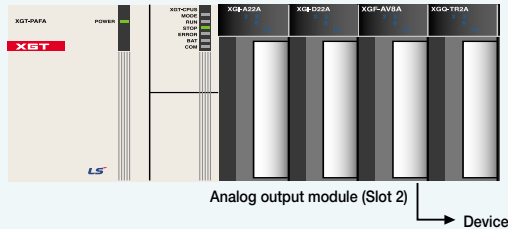

Wiring

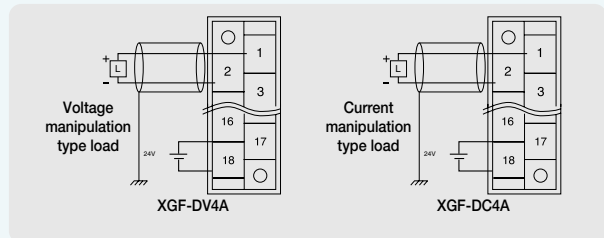

Parameter setting

In the parameter setting box, select slot and analog module that you want to use. (This example shows to select '0' channel of voltage output type.)

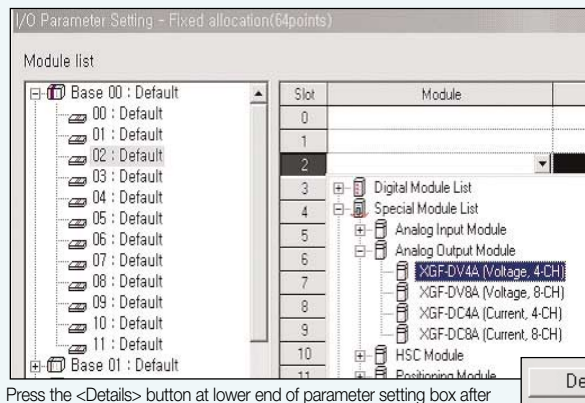

Press the <Details> button at lower end of parameter setting box after selecting the module.

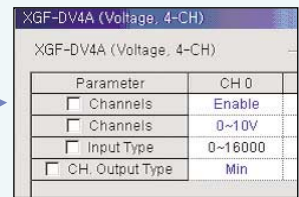

You need to fill out each item suitable for your system.

Programming

Create a program for D/A conversion (0~16000 to 0~10V).

Special devices for programming

Refer to user's manual for more details.

U02.02.0: Admitting Channel 0 output

U02.03: Output data of channel 0

Uxy.aa.bb
 x: Base number
 y: Slot number
 aa,bb: Refer to user's manual.

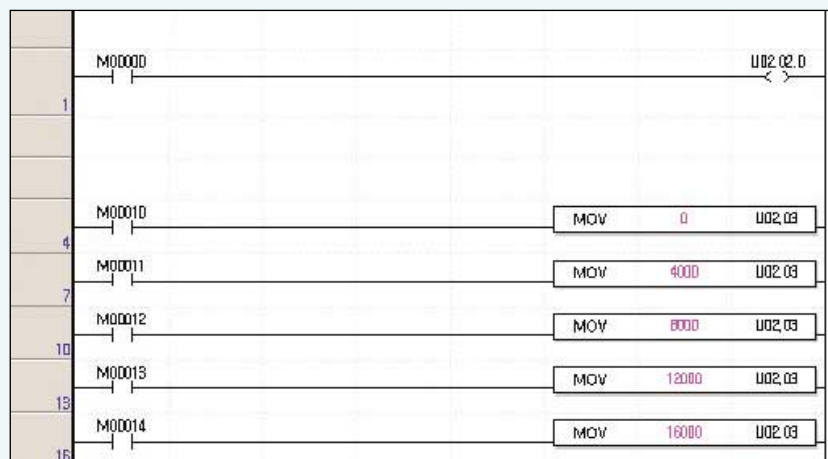

Features

- Parameter setting and monitoring using XG5000
- Incremental encoder available
- Supporting various pulse input (5V, 12V, 24V)
- Various multiplication (1/2 phase pulse input)
- External present input
- Providing function to prevent from counting external signal
- Supporting HTL-level incremental encoder in the line-drive input type



Specifications

Item		Specification			
		XGF-HO2A		XGF-HD2A	
No. of command	Signal	A Phase, B Phase			
	Input type	Voltage input (Open Collector)		Differential input (Line Driver)	
	Signal level	DC 5/12/24V		RS-422 Line Drive/HTL LEVEL Line Drive	
	Input voltage	24V DC (17.0V ~ 26.4V)	12V DC (9.8V ~ 13.2V)	5V DC (4.5V ~ 5.5V)	Line Driver RS-422 Line Drive HTL Level Line Drive
	Input current	7~11mA	7~11mA	7~11mA	
	Min. On guaranteed voltage	17.0V	9.8V	4.5V	
	Max. Off guaranteed voltage	4.5V	3.0V	1.7V	
Counter enable	Set by program (Count only in 'Enable')				
Max. counting speed	200Kpps		500Kpps (HTL input: 250Kpps)		
No. of channels	2 channels				
Counting range	Signed 32 Bit (-2,147,483,647 ~ 2,147,483,647)				
Counting type	Linear count				
(Program setting)	(Generating Carry/Borrow when exceeding counting range, Max/Min value)				
Input mode	1 Phase input				
(Program setting)	2 Phase input				
	CW/CCW input				
Signal type	Voltage				
Up/Down counter setting	1-phase input	Program or B-phase			
	2-phase input	Phase difference			
	CW/CCW	A-phase input: Up count B-phase input: Down count			
Multiplication	1-phase input	1/2 multiplication (Programming)			
	2-phase input	1/2/4 multiplication (Programming)			
	CW/CCW	1 multiplication			
Control input	Signal	Preset signal, Signal to admit additional signal (Setting by terminal block or programming)			
	Signal level	DC 5V/12V/24V input type (Selecting terminal)			
	Signal type	Voltage			
External output	No. of output point	2 points/channel: Terminal output available			
	Type	Single comparison (>,>=,<=<,<) or section comparison			
	Output type	Open Collector (Sink)			
Operating status display	Input signal	A-phase, B-phase, Preset signal, Signal to admit additional signal			
	Output signal	OUT1, OUT2			
	Operation status	Module Ready, Pulse input status of A, B phase			
Addition functions (Program setting)	<ul style="list-style-type: none"> • Count clear, Count latch • Section count (Set time value:1~60000ms) • Measuring counting number per a unit time (Set time value:1~60000ms) • Preventing from counting (Setting by internal/external input during counting) 			• Pulse frequency count (Each input channel)	
No. of occupied I/O points	Fixed type (Setting in basic parameter): 64 points				
	Variable type (Dissolving in basic parameter): 16 points				
Terminal block	40-pin connector				
Current consumption	270		330		
Weight (Kg)	0.09				

Terminal block configuration

XGF-HO2A

Pin layout	Pin number		Signal name
	CHO	CH1	
	1	17	A12V A phase DC12V input
	2	18	A24V A phase DC24V input
	3	19	A_C A phase COM
	4	20	A5V A phase DC5V input
	5	21	B12V B phase DC12V input
	6	22	B24V B phase DC24V input
	7	23	B_C B phase COM
	8	24	B5V B phase DC5V input
	9	25	P12V Preset DC12V input
	10	26	P24V Preset DC24V input
	11	27	P_C Preset COM
	12	28	P5V Preset DC5V input
	13	29	G12V Gate DC12V input
	14	30	G24V Gate DC24V input
	15	31	G_C Gate COM
	16	32	G5V Gate DC5V input
	33	35	OUT1 Comparison output OUT1
	34	36	OUT0 Comparison output OUT0
	37	38	24V External power supply
	39	40	24G DC24V

XGF-HD2A

Pin layout	Pin number		Signal name
	CHO	CH1	
	1	17	AI- AI-Input (LINE DRIVE TTL LEVEL Input)
	2	18	AI+ AI+Input (LINE DRIVE TTL LEVEL Input)
	3	19	AI- AI-Input (LINE DRIVE HTL LEVEL Input)
	4	20	AI+ AI+Input (LINE DRIVE HTL LEVEL Input)
	5	21	BI- BI- Input (LINE DRIVE TTL LEVEL Input)
	6	22	BI+ BI+Input (LINE DRIVE TTL LEVEL Input)
	7	23	BI- BI-Input (LINE DRIVE HTL LEVEL Input)
	8	24	BI+ BI+Input (LINE DRIVE HTL LEVEL Input)
	9	25	P12V Preset DC12V input
	10	26	P24V Preset DC24V input
	11	27	P_C Preset COM
	12	28	P5V Preset DC5V input
	13	29	G12V Gate DC12V input
	14	30	G24V Gate DC24V input
	15	31	G_C Gate COM
	16	32	G5V Gate DC5V input
	33	35	OUT1 Comparison output OUT1
	34	36	OUT0 Comparison output OUT0
	37	38	24V External power supply
	39	40	24G DC24V

Configuration

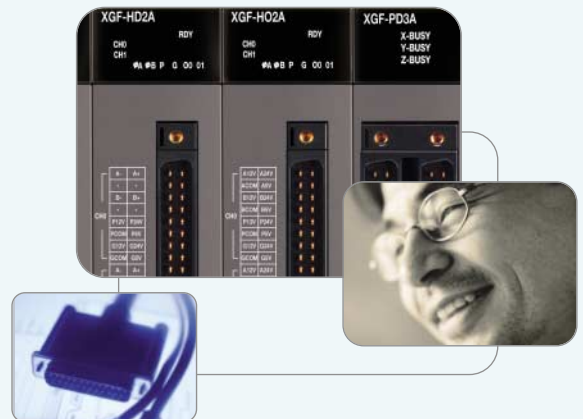
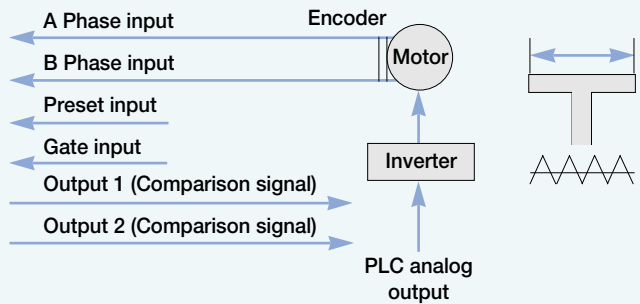
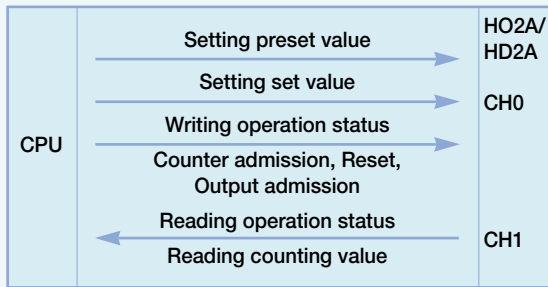

Special

Special module / High-speed counter module (Example)

This is a simple example of high-speed counter module setting.
For more details, refer to user's manual.

System configuration

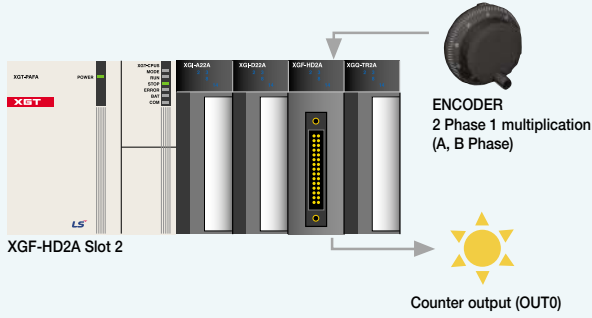

Wiring

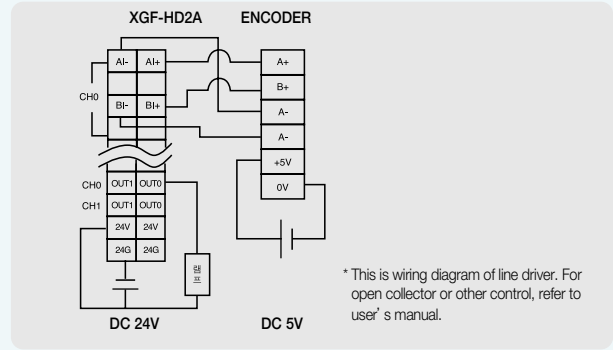

Control configuration

- Light a lamp of output when present value reaches 1000 of pulse input counted by encoder.
- Current value of pulse is saved in D100~D101 and is monitored.

Module test (Online)

- Module test function of XGT enables to monitor operation status of high-speed counter module and to test-run.



Select [Monitor] → [Special Module Monitoring] in menu and appoint high-speed counter.



After pressing the button for [Start Monitoring], press the button [FLAG monitor].

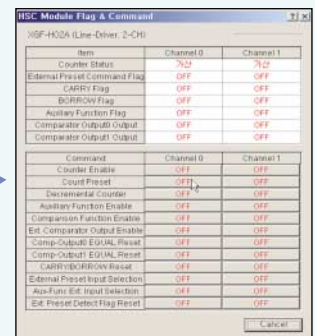

Change [Counter Enable] status to ON.

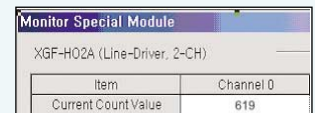

Check current counting value in 'Monitor Special Module' screen box.

Parameter setting

- In I/O parameter setting box, select slot and analog module that you want to use.
(This example shows to select 2-channel line driver.)

Press the <Details> button at lower end of parameter setting box after selecting the module.

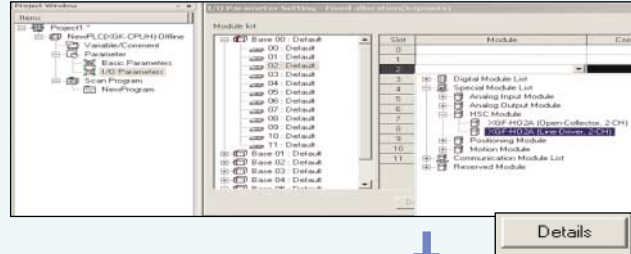

Input 1000 as Max. and Min. comparison output.

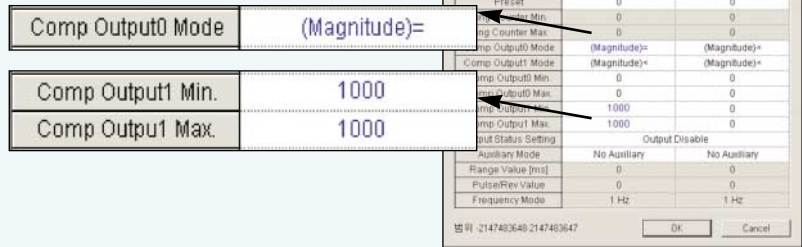

Programming

- After completing programming like following figure, download it to PLC and check operation status.

Special devices for programming

Refer to user's manual for more details.

- U02.23.0: Count operation admission
- U02.23.1: Count preset
- U02.23.4: Consistent output admission
- U02.23.5: Output external terminal admission
- U02.23.6: OUT0 consistent signal reset
- U02.00.6: Contact for checking external output (Practically effective output is outputted through OUT0 terminal)
- U02.02-U02.03: Counter present value

Uxy.aa.bb
x: Base number
y: Slot number
aa,bb: Refer to user's manual

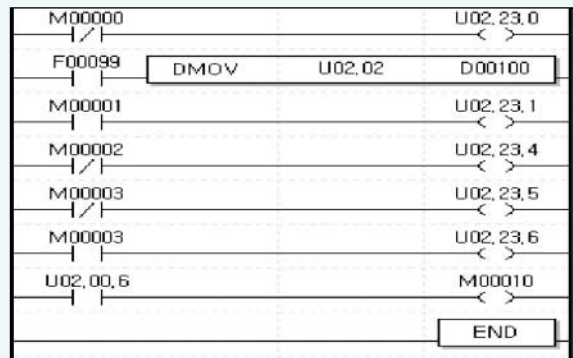

After downloading, monitor operation status.

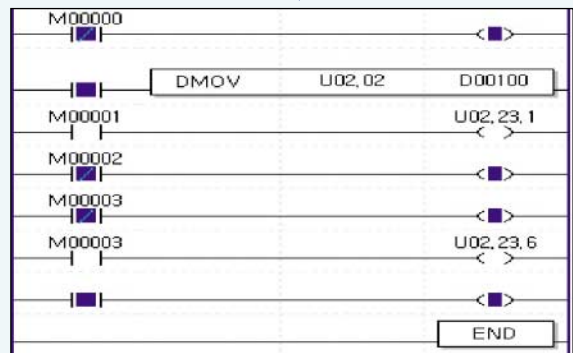

For monitoring just present value, follow the example.

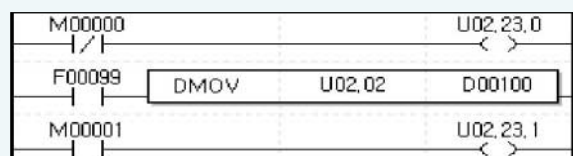

Features

- Highly reliable position control with LSIS ASIC-embedded processor
- Enhanced control with fast control processing speed
- High-speed motor control (Max. pulse output: 1Mbps)
- Circular/linear interpolation, separate/synchronous operation
- Trapezoidal & S-curve acceleration/deceleration
- Easy and quick control through external input (JOG operation included)
- Encoder input support
- High-speed processing of command (4ms)
- Easy to set positioning parameters (Windows)
- Monitoring/Tracking/Simulation
- Available to edit operation parameter data in EXCEL
- Self-diagnosis
- Real-time information and solution for each error



Specifications

Item	Specifications		
	XGF-PO1A, XGF-PD1A	XGF-PO2A, XGF-PD2A	XGF-PO3A, XGF-PD3A
Number of axis	1	2	3
Interpolation	2-axis linear interpolation, 2-axis circular interpolation		2/3-axis linear interpolation, 2-axis circular interpolation
Control method	Position control, speed control, speed/position control, position/speed control		
Setting unit	Pulse, mm, inch, degree		
Positioning data	Each axis has 400 data items (Operation step number 1~400). It is available to set with software package or programming.		
Software package	Available (Connected with RS-232C Port of CPU module)		
Data backup	Flash memory (No battery)		
Positioning	Positioning method		Absolute / relative method
	Position address range	mm	-214748364.8 ~ 214748364.7 (μm)
		Inch	-21474.83648 ~ 21474.83647
		Degree	-21474.83648 ~ 21474.83647
		Pulse	-2147483648 ~ 2147483647
	Type		XGF-PO□A: Open collector, XGF-PD□A: Line Driver
	Position speed range	mm	0.01 ~ 2000000.00 (mm/min)
		Inch	0.001 ~ 200000.000 (inch/min)
		Degree	0.001 ~ 200000.000 (degree/min)
		Pulse	XGF-PO□A: 1~200,000 (pulse/sec), XGF-PD□A: 1~1,000,000 (pulse/sec)
Accel/Decel pattern		Trapezoidal & S-curve acceleration/deceleration	
Accel/Decel time		1 ~ 65,535ms	
Max. output pulse	XGF-PO□A: 200Kpps / XGF-PD□A: 1Mpps		
Max. distance	XGF-PO□A: 2m / XGF-PD□A: 10m		
Max. encoder input	200 Kpps		
Error display	LED		
Operation display	LED		
Connection connector	40 Pin connector		
Size of cable	AWG #24		
Occupied points of I/O	64 points (Fixed type), 16 points (Variable type)		
Current consumption (mA)	XGF-PO1A: 340	XGF-PO2A: 360	XGF-PO3A: 400
	XGF-PD1A: 510	XGF-PD2A: 790	XGF-PD3A: 860
Weight (kg)	0.12	0.13	0.135

* XGF-PO□O: Open Collector type, □: Number of axis
 XGF-PD□D: Line Drive type, □: Number of axis

Terminal block configuration

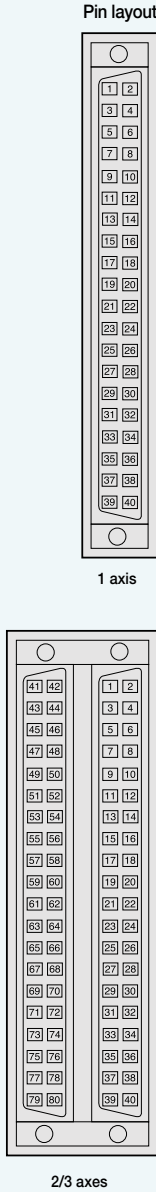

For	Pin number			Signal name	Signal direction APM - Ext. device	Condition
	X	Y	Z			
A x i s	21	41	61	FP+	Pulse output (Differential +)	→
	22	42	62	FP-	Pulse output (Differential -)	→
	23	43	63	RP+	Pulse sign (Differential +)	→
	24	44	64	RP-	Pulse sign (Differential -)	→
	25	45	65	OV+ *	High limit	←
	26	46	66	OV- *	Low limit	←
	27	47	67	STOP	External stop signal	←
	28	48	68	DOG	Approximate origin	←
	29	49	69	VTP	Speed/Position switching signal	←
	30	50	70	ECMD command signal	Start	←
					Skip	←
					JOG+ (Forward)	←
	31	51	71	JOG-	JOG reverse operation	←
	32	52	72	COM	Common (OV+, OV-, STOP, DOG, VTP, ECMD, JOG-)	↔
	33	53	73	DR/INP	Imposition/Driver Ready signal	←
	34	54	74	DR/INP COM	Imposition/Driver Ready signal Common	↔
35	55	75	HOME +24V	Zero signal (+24V)	←	
36	56	76	NC	Not used		
37	57	77	HOME +5V	Zero signal (+5V)	←	
38	58	78	HOME COM	Zero signal (+24V, +5V) Common	↔	
39	59	79	24V	24V Power supply (Not used in case of line drive output)		
40	60	80	P COM	External 24V GND (Not used in case of line drive output)		
C o m m o n		1	MPG A+	Manual pulse generator/Encoder A+ Input	←	
		2	MPG A-	Manual pulse generator/Encoder A- Input	←	
		3	MPG B+	Manual pulse generator/Encoder B+ Input	←	
		4	MPG B-	Manual pulse generator/Encoder B- Input	←	
		5	NC	Not used	←	
		6	NC	Not used	←	
		7	CON	External simultaneous start	←	
		8	EMG *	Emergency stop	←	
		9	NC	Not used		
		10	COM	(CON, EMG) Common	↔	
	11~20	NC	Not used			



Special

Connection with MR-J2/J2S-□A

- XGF-PD1/2/3A (Line Driver)

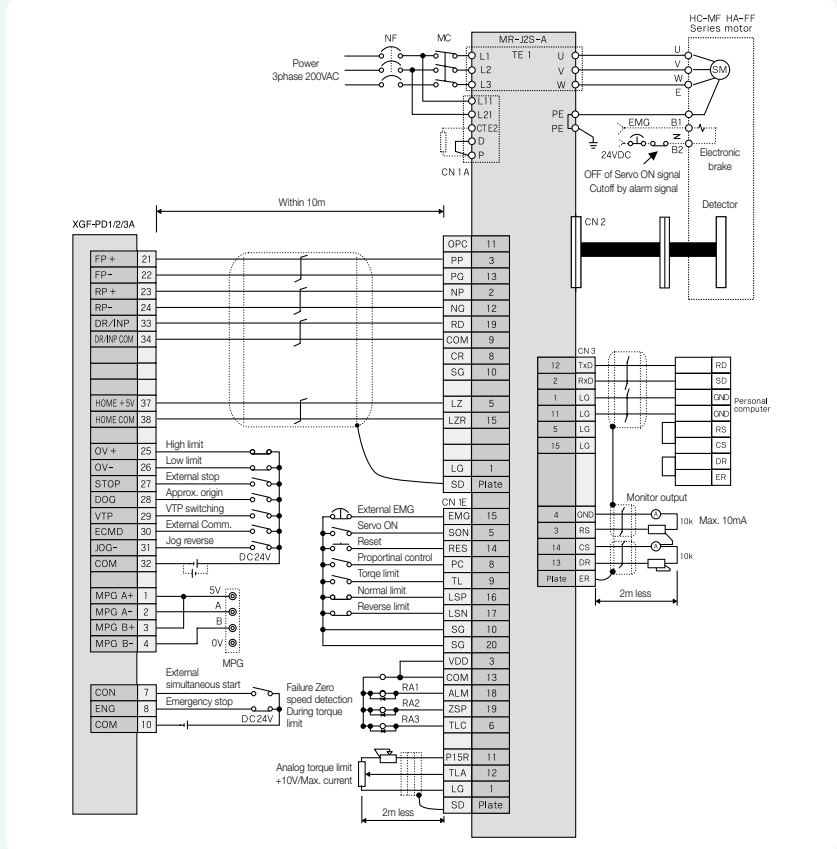

- XGF-PO1/2/3A (Open Collector)

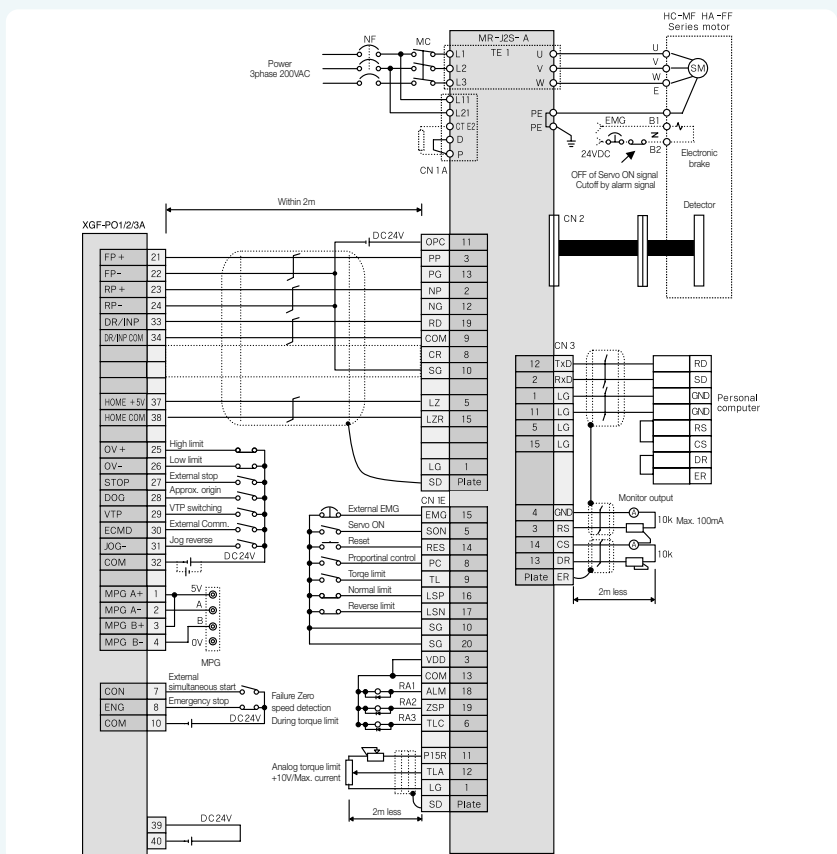

Connection with FDA-3000 AC Servo driver

- XGF-PO1/2/3A (Open Collector)

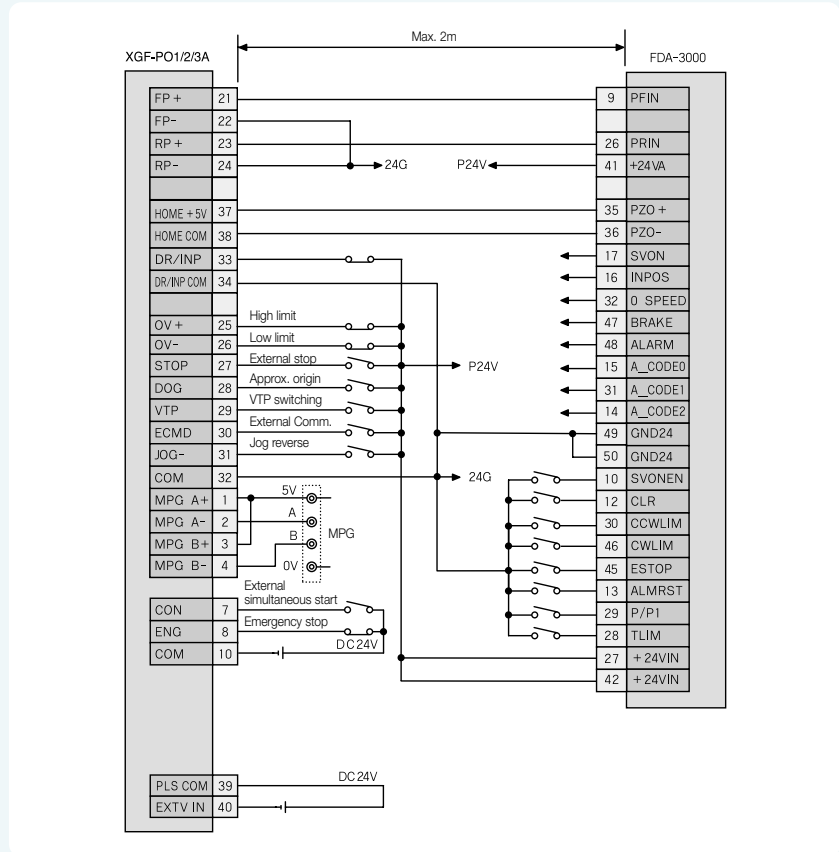

Connection with FDA-5000 AC Servo driver

- XGF-PO1/2/3A (Open Collector)

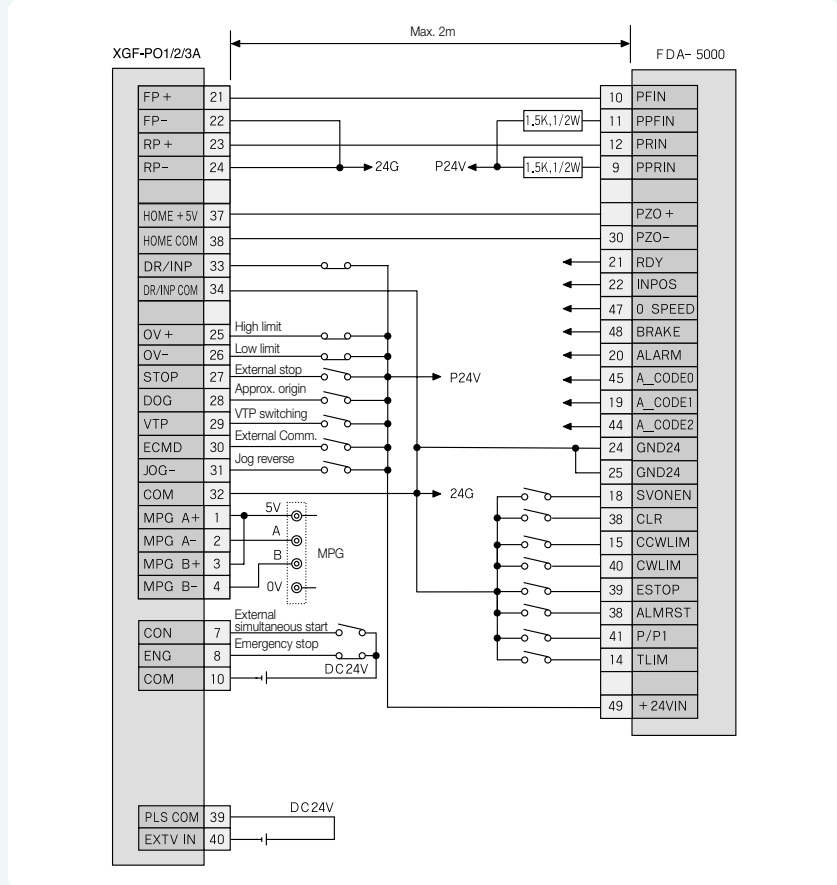

- XGF-PD1/2/3A (Line Driver)

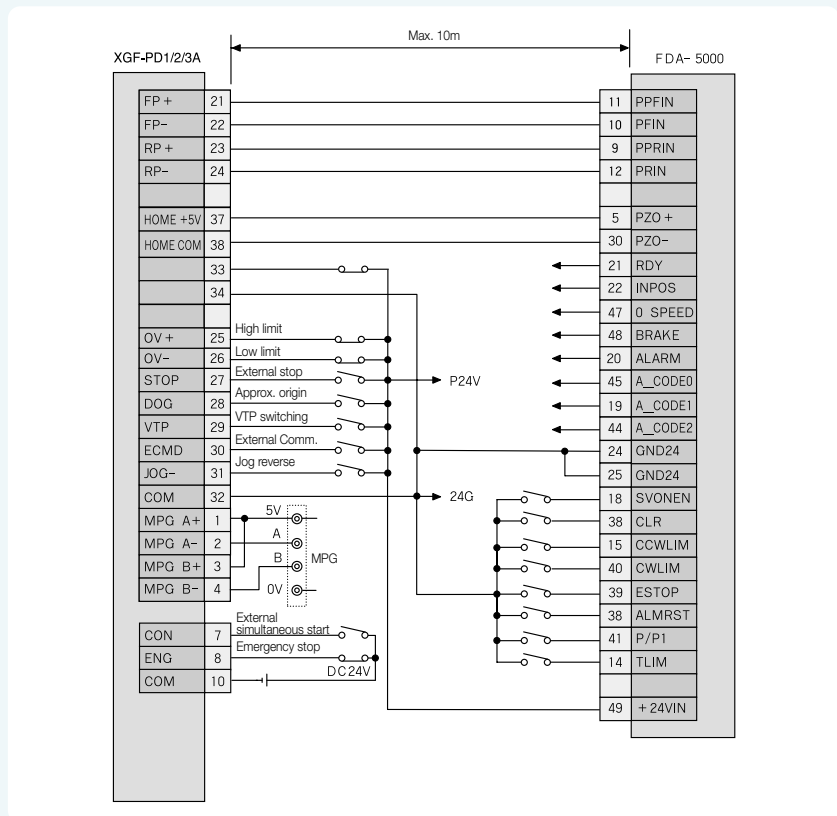

Special module / Positioning module (Example)

This is a simple example to control 1-axis servo motor.

System configuration

- Positioning system consists of control part, power part, and machinery part.
- Control part: Install APM module on base and complete parameter setting and programming.
- Power part: Power part generates momentum, and it consists of [servo-driver + servo-motor] and [step-driver + step-motor].
- Machinery part: Machinery part is to transport objects, and it can be ball screw, timing belt and rack gear.

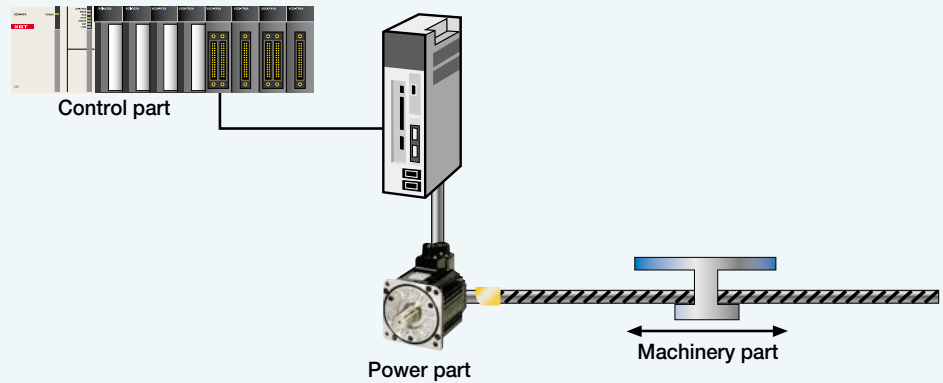

System design

- APM: Determine type and quantity considering the number of control axis and operation function.
- Driver: Select driver with identical output type of APM.
(In case output type of APM is line driver, driver should support a pulse train input type of line driver.)
- Motor: Select capacity considering operation characteristics of load.
- Mechanical: Design precise mechanical system to minimize error.

Connection to drivers

- The following picture is wiring pulse train signal between driver and APM for pulse train signal.
- Terminal besides pulse train signal is used additionally according to user-purpose, system characteristics.
- For wiring of optional terminal of Servo (Step) driver, refer to user's manual.

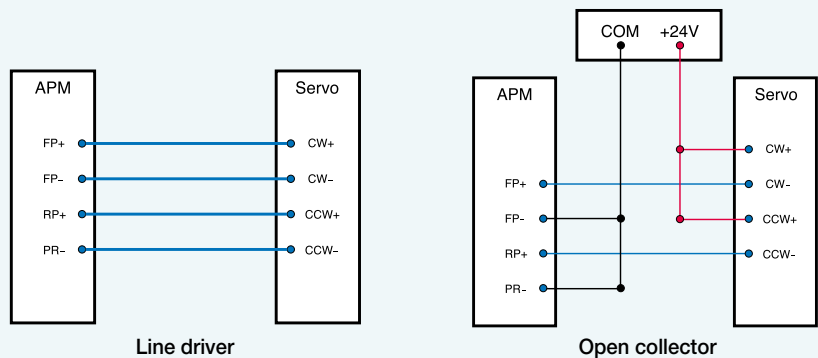

Parameter, data setting and transmission

- Set system characteristic, target location, operation speed, and operation type using APM software package.
- Transmit operation parameter and data to APM.

	Item	X-Axis
Basic Parameter	Unit	1 mm
	Pulse per Rotation	5000 pls
	Travel per Rotation	5000.0 um
	Unit Multiplier	0 x 1
	Pulse Output Mode	0 CW/CCW
	Bias Speed	0.01 mm/m
	Speed Limit	10000.00 mm/m
	ACC/DEC No.1	500 ms
	ACC/DEC No.2	1000 ms
	ACC/DEC No.3	1500 ms
ACC/DEC No.4	2000 ms	
	S/W Upper Limit	214748364.7 um
	S/W Lower Limit	-214748364.8 um
	Backlash Comp	0.0 um
	Position Complete Time	1000 ms
	Ext. Command Selection	0 Start

Setting parameter of system characteristic



APM software package

Step	Code	Control	Pattern	Method	Address [um]	Sub-Address [um]	M Code	A/D No.	Speed [mm/m]	Dwell [ms]	Ck Int Dr
1	ABS	POS	END	SIN	0.0	0.0	0	No.1	0.00	0	CW
2	ABS	POS	END	SIN	0.0	0.0	0	No.1	0.00	0	CW
3	ABS	POS	END	SIN	0.0	0.0	0	No.1	0.00	0	CW
4	ABS	POS	END	SIN	0.0	0.0	0	No.1	0.00	0	CW

Target location, speed, operation type, operation data

Initial system inspection

- Perform a trial-run using APM Software Package, and check external wiring, operation data setting, and status of machinery part. It is recommended to do trial-run before programming.
- If a program is saved in CPU and operation mode is 'RUN', a unexpected fault can occur due to disagreement between operation condition of operation control program and operation result of APM Software Package.

Special

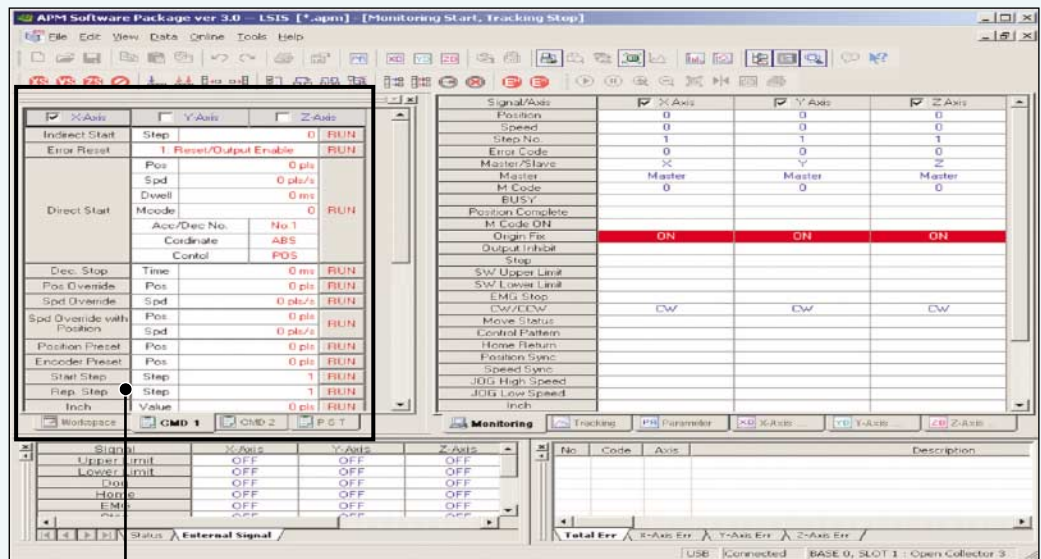

Operate APM without positioning programming

Programming

- Create a program using dedicated command for APM control.
ex) Origin point return-ORG, Independent operation-IST

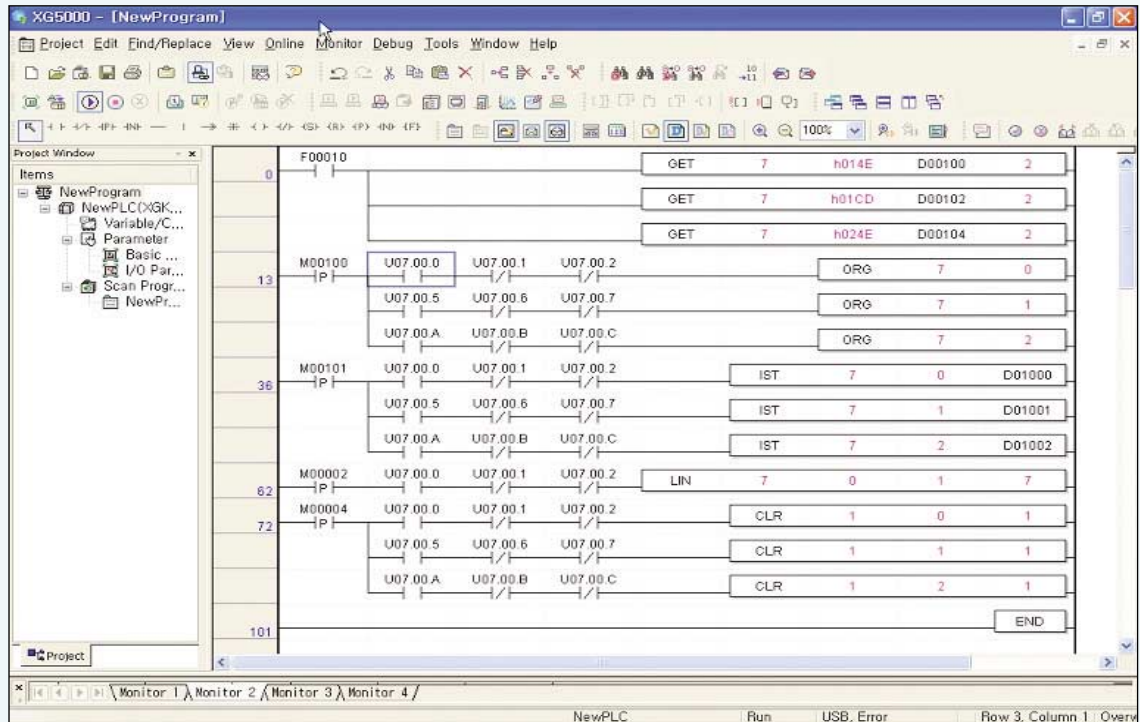

Program monitoring

- Monitor output condition following input condition and inspect operation status of APM and correct programming error.

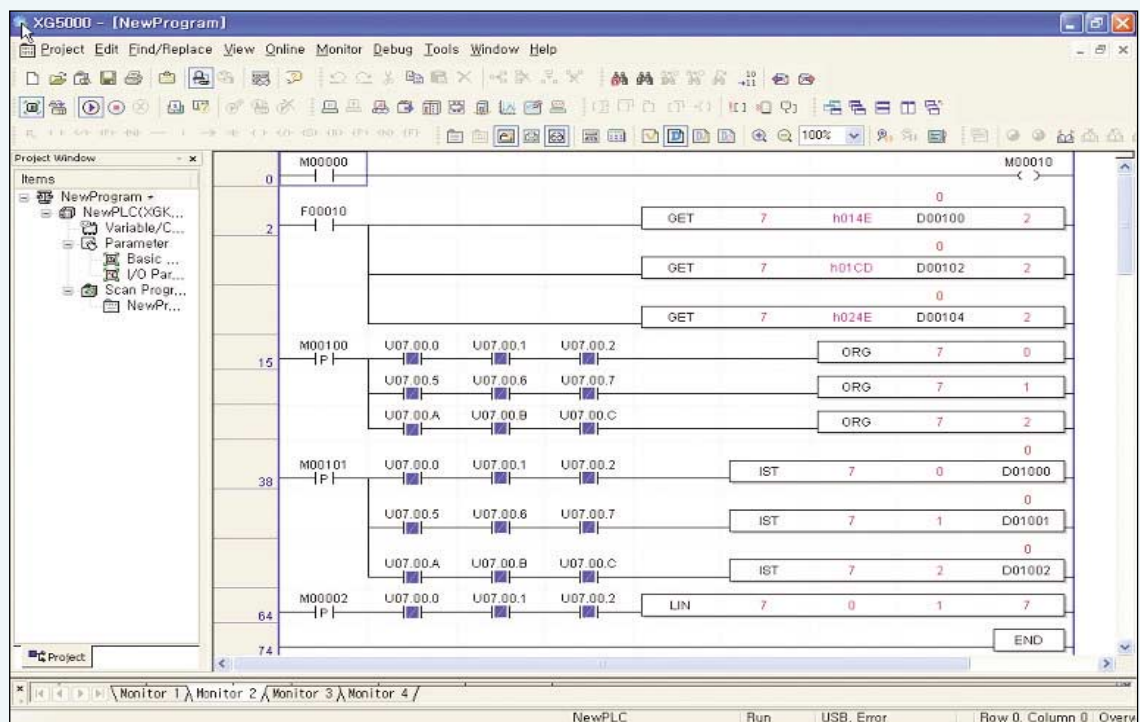

Features

- Supports various additional functions (average, alarm, filter)
- Special module parameter setting and monitoring with XG5000
- Supports digital conversion, temperature display and user scaling

Specifications

Item		XGF-RD4A	XGF-RD4S
No. of input channel		4 channels	4 channels
Input sensor type	Pt100	JIS C1604-1997	JIS C1604-1997
	JPt100	JIS C1604-1981, KS C1603-1991	JIS C1604-1981, KS C1603-1991
	PT1000	-	JIS C1604-1997
	NI100	-	DIN 43760-1987
Temperature input range	Pt100	-200.0 ~ 850.0°C	-200.0 ~ 850.0°C
	JPt100	-200.0 ~ 640.0°C	-200.0 ~ 640.0°C
	PT1000	-	-200.0 ~ 850.0°C
	NI100	-	-60.0 ~ 180.0°C
Digital output (unit: 0.1)	Temperature display	Pt100: -2,000 ~ 8,500 JPt100: -2,000 ~ 6,400	Pt100: -2,000 ~ 8,500 JPt100: -2,000 ~ 6,400
	Scaling display (Customize)	-	0 ~ 65535 -32768 ~ 32767
	Accuracy	Normal temp.(25°C): ±0.2% Full temp.(0~55°C): ±0.3%	±0.1% ±70ppm/°C
	Conversion speed	-	40ms / channel
Insulation	Channel to Channel	Non-insulation	Insulation
	Terminal to PLC Power	-	Photo-coupler
Wiring method		3-wire	4-wire
Function	Average	-	Time average (320~64000ms) Counting average(2~64000 count) Moving average(2~100 samples)
	Alarm	-	Process alarm Input changing rate alarm Disconnection detection
	Filtering	-	Digital filter (160~64000ms)
Terminal block		-	18-point terminal block
Current consumption		5V: 450mA	5V: 720mA
Weight [g]		-	150g

Characteristics of temperature conversion

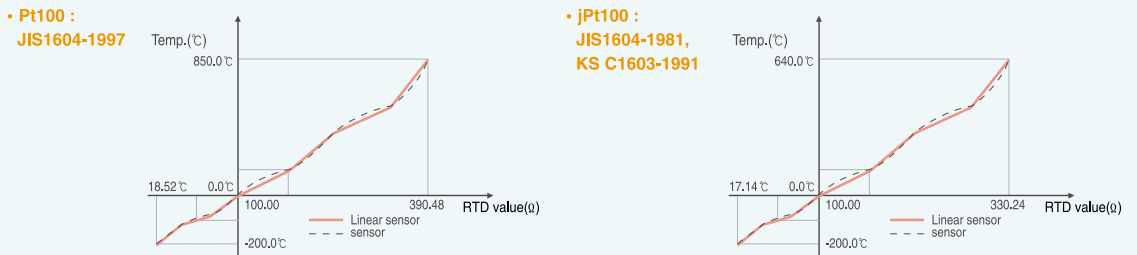

Wiring

• Connection with 2-wire type sensor

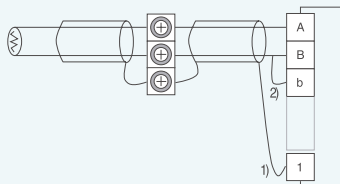

• Connection with 3-wire type sensor

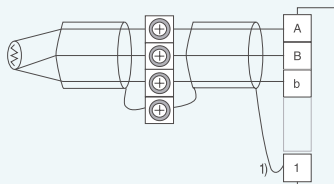

• Connection with 4-wire type sensor

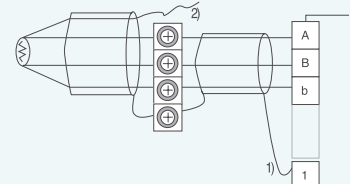

1) When sensor and compensating wire are shielded, shield-connection to FG terminal of the module is available.

2) The wiring of 4-wire type sensor is identical with the wiring of 3-wire type sensor. 3 wires is connected to the module. But the other wire is not connected with the module.

Special module / Thermocouple module

Features

- Insulation between channels
- $\pm 0.1\%$ (25°C) constant density
- Supports various input sensor (supporting C-type sensor)
- Various additional functions (average, filter, alarm, max/min value display)
- Special module parameter setting and monitoring with XG5000

Specifications

Item	XGF-TC4S	
Input channels	4 channels	
Input sensor type	K, J, E, T, B, R, S, N, C	JIS C1602-1995ITS-90
Input temperature range	K	-250 ~ 1350°C
	J	-200 ~ 1200°C
	E	-250 ~ 1000°C
	T	-250 ~ 400°C
	B	400 ~ 1800°C
	R	-50 ~ 1750°C
	S	-50 ~ 1750°C
	N	-270 ~ 1300°C
Digital output	Temperature display (unit: 0.1)	Display down to the first decimal place (0.1°C)
	Scaling	0 ~ 65535
	(User range setting)	-32768 ~ 32767
Accuracy	Normal temp. (25°C)	$\pm 0.1\%$
	Temperature coefficient (Operating temp. range)	Some section can permit 0.5% $\pm 100\text{ppm}^\circ\text{C}$
Conversion speed	40ms/ channel	
Insulation	Between channels	Insulation
	Between terminals and power	Insulation(Photo-Coupler)
Compensation	Automatic compensation by RJC sensing (PT100)	
	Compensation degree	$\pm 1.0\%$
Function	Average	Average time (320 ~ 6400ms)
		Average number (2~ 64000)
		Average move (2 ~100)
	Alarm	Process Alarm
		Change rate alarm
	Filter	Digital filter (160 ~ 64000ms)
Max./Min. values display	Max./Min. values display	
Terminal block	18-point terminal block	
Current consumption	5V : 610mA	
Weight (kg)	0.150	

Special

Input wiring

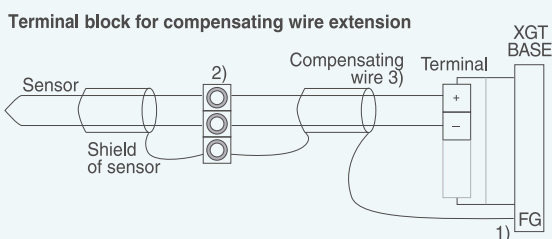

- 1) When sensor and compensating wire are shielded, shield connection to FG terminal is available.
- 2) To minimize an error, overall temperature of block terminal need to be equal.
- 3) Compensating sensor should be the same type of sensor which is used for measurement.

Characteristics of I/O conversion

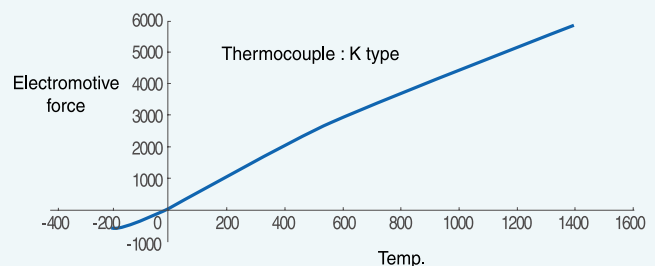

Features

- Optimum temperature control
- Universal input: TC, RTD, Voltage, Current
- Isolated input
- Output: Current/Transistor
- Parameter setting via dedicated software: TG-CON
- Variety of control types
 - PID control
 - Cascade control
 - On/ Off control
- Disconnection detection
- Various input functions: Bias, Filter, Square root
- Auto-tuning



Specifications

Item	XGF-TC4UD		
No. of loop	4 loops		
Input	Thermo couple	K	-200 ~ 1300°C
			0 ~ 500°C
		J	-200 ~ 1200°C
			0 ~ 500°C
		E	-200 ~ 1000°C
		T	-200 ~ 400°C
		B	400 ~ 1800°C
		R	0 ~ 1700°C
		S	0 ~ 1700°C
		N	-200 ~ 1300°C
	C(W5Re/W26Re)	0 ~ 2300°C	
	PL II	0 ~ 1300°C	
	L	-200 ~ 900°C	
	U	-200 ~ 600°C	
	RTD	Pt100	-200 ~ 850°C
		JPt100	-200 ~ 600°C
		Pt1000	-200 ~ 800°C
	Voltage	DC mV	0 ~ 10mV
			0 ~ 100mV
		DC V	0 ~ 1V
1 ~ 5V			
0 ~ 5V			
0 ~ 10V			
-5V ~ 5V			
10V ~ 10V			
Current	DC mA	4 ~ 20mA	
		0 ~ 20mA	
Input channel	4 channels (Input type selection per channel)		

Specifications

Item	XGF-TC4UD				
Resolution	Resolution Refer to the user's manual (Resolution for each input type)				
Cold junction compensation	Compensation	Automatic compensation by RJC sensor			
	Precision	±0.2°C			
Digital output	Temperature display	0.1°C/1°C (Selection by software)			
	Linear display	0~1000			
	Scale display	Only for voltage/current input Range : -3,000~3,000 Setting range: 0~3000			
Control type	0.2sec/4 loops				
Conversion speed	PID, On/Off control				
Parameter	Set value (SV)	Selection per input type			
	Gain	0 : ON/OFF control, Real type			
	Integrated time	0 : No Differential control, Real type			
	Differential time	0 : No Integrated control, Real type			
Output	No. of output channel		8 channels (PWM or analog output)		
	PWM	Rated load voltage	DC 24V		
		Max. current point	0.1A points		
		On voltage drop	DC 0.3V or less		
		Off leakage current	0.1mA or less		
		Response time	ON ⇒ OFF	1ms or less	
			OFF ⇒ ON	1ms or less	
		Periodic	0.5~120.0sec (resolution: 0.5sec)		
	Time resolution	High value between 10ms or 0.5% of full scale			
	Analog output	Range	4~20mA		
		Resistance	600 Ω or less		
		Resolution	±1.0%, 25°C		
		Precision	8μA		
Item		Insulation	Insulation withstand voltage	Insulation resistance	
Insulation	Channel - Channel	Trans	500V AC, 50/60Hz 1min, Leakage 10mA or less	500V DC, 10M Ω or more	
	Input terminal - PLC	Photocoupler			
	Current output - Current output	Non insulation			
	External power- Output	Non insulation			
Warm-up	20min or more				
Terminal	18 points terminal				
Power	5V, DC 24V (external)				
Current consumption	DC 5V : 900mA (Internal)				
	DC 24V : 300mA (external)				

Special

Example: Constant temperature

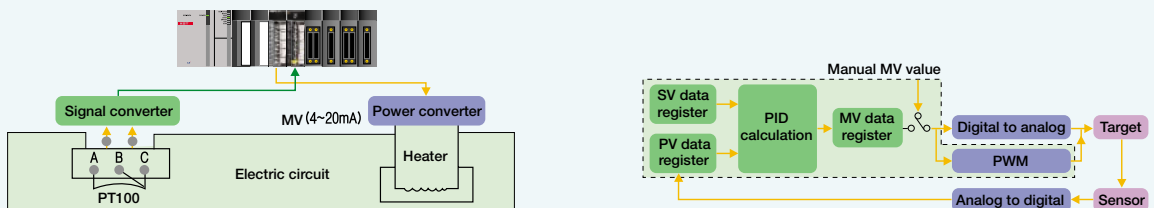

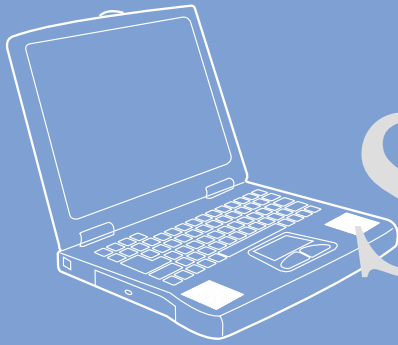

Software

Software innovation for integrated solution.

XG5000 is the optimum software which can cover various programming needs, debugging, and easy maintenance. Especially, XG-PD achieves customer satisfaction with useful maintenance tool by internet.



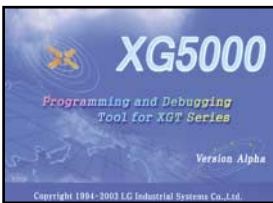

Programming software XG5000

- Program editing & Engineering software
- Windows-based easy operation
- Multi-PLC, Multi-programming support
- Various monitoring and diagnosis functions
- Windows 2000, XP (Limited use in Windows 98, ME)

Ladder monitor

Variable monitor

PLC	Type	Device	Address	Variable	Comment
1	PLC1	RELAY	000000	001	Relay 000000
2	PLC1	RELAY	000001	002	Relay 000001
3	PLC1	RELAY	000002	003	Relay 000002
4	PLC1	RELAY	000003	004	Relay 000003
5	PLC1	RELAY	000004	005	Relay 000004
6	PLC1	RELAY	000005	006	Relay 000005
7	PLC1	RELAY	000006	007	Relay 000006
8	PLC1	RELAY	000007	008	Relay 000007
9	PLC1	RELAY	000008	009	Relay 000008
10	PLC1	RELAY	000009	010	Relay 000009
11	PLC1	RELAY	000010	011	Relay 000010
12	PLC1	RELAY	000011	012	Relay 000011
13	PLC1	RELAY	000012	013	Relay 000012
14	PLC1	RELAY	000013	014	Relay 000013
15	PLC1	RELAY	000014	015	Relay 000014
16	PLC1	RELAY	000015	016	Relay 000015
17	PLC1	RELAY	000016	017	Relay 000016
18	PLC1	RELAY	000017	018	Relay 000017
19	PLC1	RELAY	000018	019	Relay 000018
20	PLC1	RELAY	000019	020	Relay 000019

Forced I/O

System monitor

Trend monitor

Special module monitor

Programming XG5000

Easy how to use
Letter type, color, short key, tool bar

Convenient editing
Undo, Redo, Excel editing

Structuralized program
Scan, task (Initialization, normal cycle, external contact point, internal device)

Various monitoring
Special module, trend, user-event, etc

Network set up, diagnosis XG-PD

Communication module parameter setting
Basic, high-speed link parameter setting

System diagnosis and monitoring
Ping/Self test
Monitoring of sending/receiving frame
Display of status and diagnosis of each module

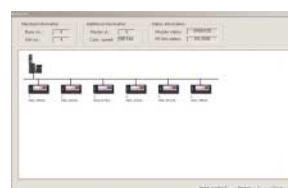

Positioning APM S/W Package

Easy parameter setting

Data editing in Excel

Monitoring and trace

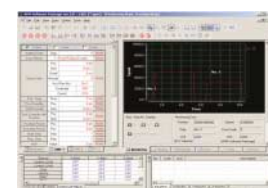

System requirement

Item	System requirement
O/S	Windows 2000, XP (Limited use in Windows 98, ME)
CPU	IBM compatible PC with Min. 200MHz Pentium processor
Memory	Min. 128M
HDD	100 MB (Free memory space)
Serial port	Communication port for program transmission (RS-232C, USB)
Printer	Compatible with Windows 98 or later
Mouse	Compatible with Windows 98 or later

Variable and programming editing

- Data input like EXCEL
- Cell-unit edit
- Auto Fill function
- Compatible with Microsoft Excel
- Redo and Undo (Unlimited)
- Segment screen edit

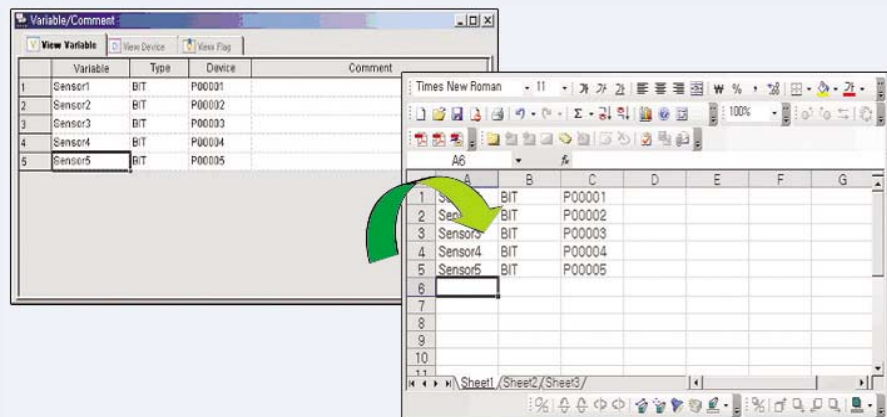

Improved diagnosis and maintenance



Module exchange wizard
It supports safe module exchange during 'RUN' mode.

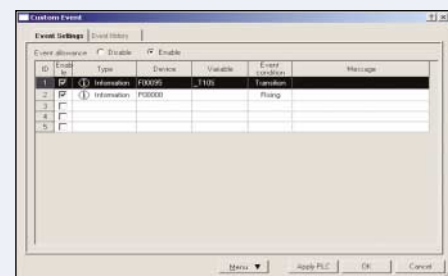

User-defined event
By registering user-defined event, users can read the record of specified event and use it for PLC operation and debugging.



Forced I/O
The status of external output device can be checked without program. And when input device breaks down, forced input function specifies ON/OFF and can operate the system without interruption of equipment.

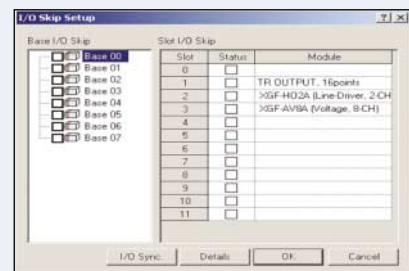

I/O skip, Error Mask
I/O inspection and renewal can be set for specific module and continuous operation is available when an error is occurred.

Program editing

- Start XG5000
- Select [New Project]
- Write project name and select CPU type

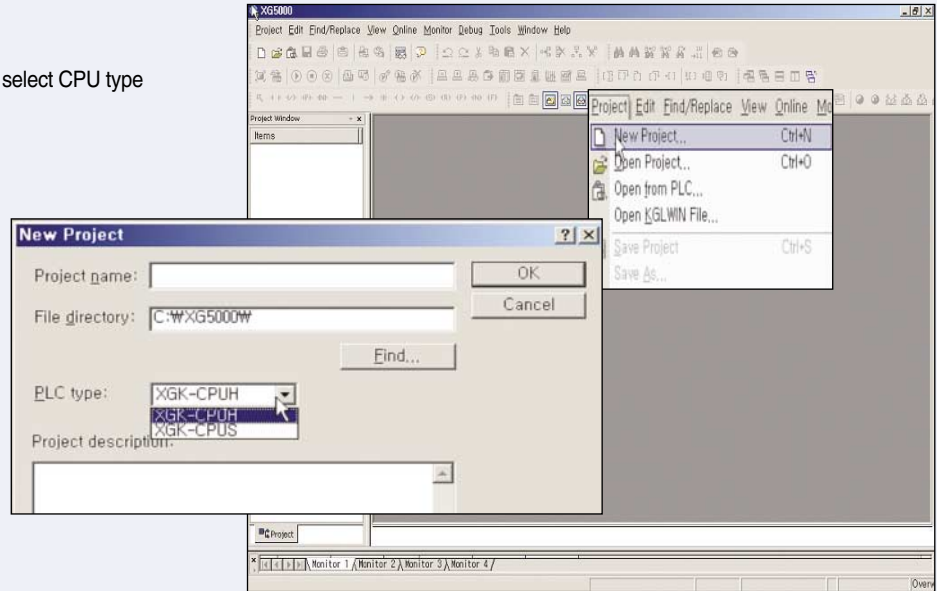

Configure ladder lines as below with ladder input tool bar

- Select input point and command with ladder tool bar.

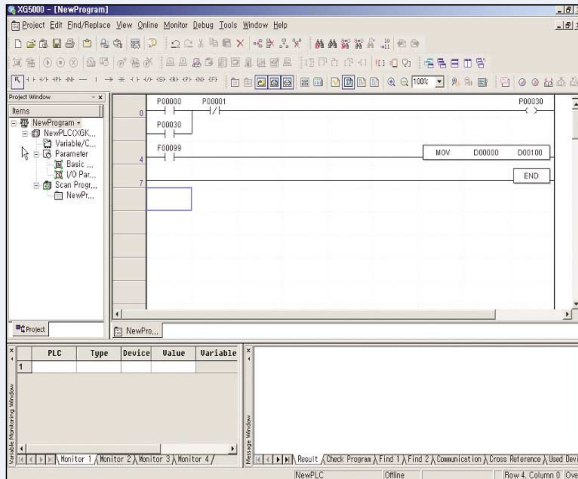

Icon	Description	Short key
	Arrow mode	ESC
	Normally open contact	F3
	Normally closed contact	F4
	Positive transition-sensing contact (On for 1 scan when Off-->On)	Shift+F1
	Negative transition-sensing contact (On for 1 scan when On-->Off)	Shift+F2
	Horizontal line	F5
	Vertical line	F6
	Fill horizontal line.	Shift+F8
	Coil	F9
	NOT instruction contact	Shift+F9
	Negated coil	F11
	SET coil	Shift+F3
	RESET coil	Shift+F4
	Positive transition-sensing coil (On for 1 scan when Off-->On)	Shift+F5
	Negative transition-sensing coil (On for 1 scan when On-->Off)	Shift+F6
	Function	F10

Note) Addition of 'EDGE' detection instructions

Develop user-friendly programming through adding D, D NOT instructions (Rising EDGE, dropping EDGE) to contact and output coil.

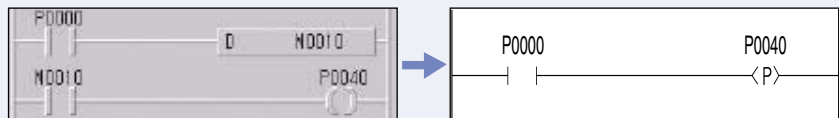

Program download

Connection setting

- Check a setting for connection between XGT and XG5000
- XGT supports USB and RS-232C

Set up communication port and download speed

* using "USB TO RS-232C" converter, 115,200bps connection may be unavailable depending on characteristics of converter. In this case, change the communication speed to 38,400bps.

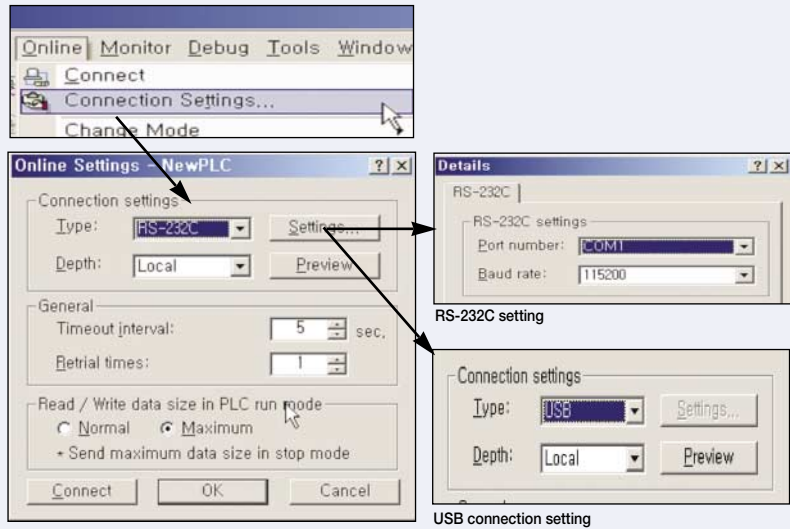

Connection

Connect to PLC and download the program as below.

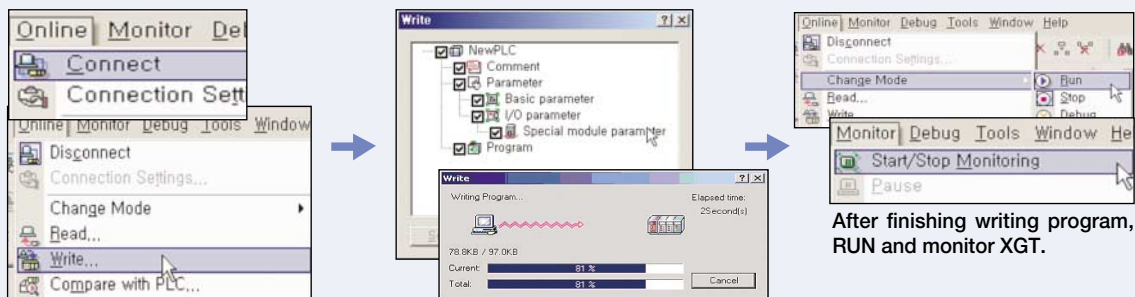

After finishing writing program, RUN and monitor XGT.

Short icon

* XGT doesn't support collective-writing monitoring for system safety.

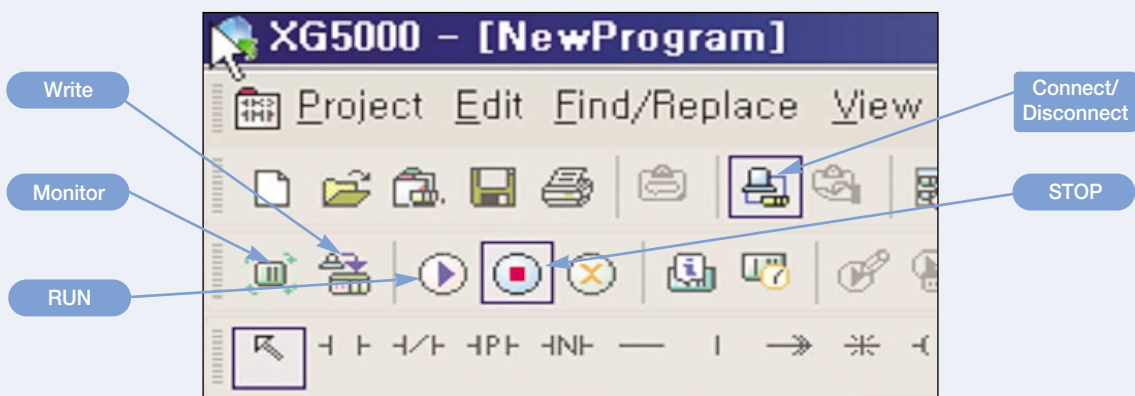

Online Editing

Select [Start Online Editing] in Online menu.

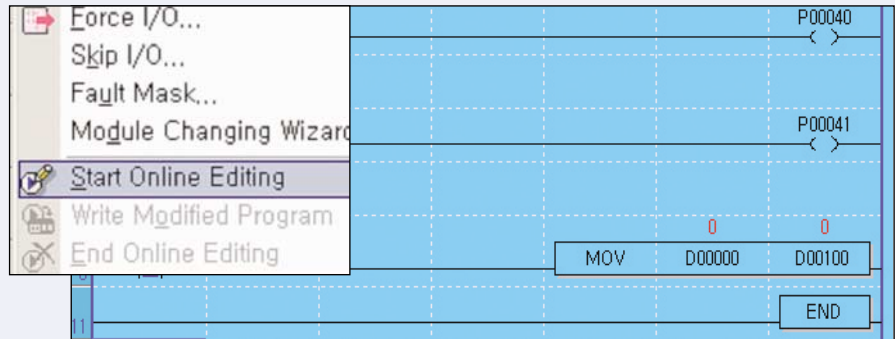

When starting Online Editing, the screen color becomes blue.

Modify the program.

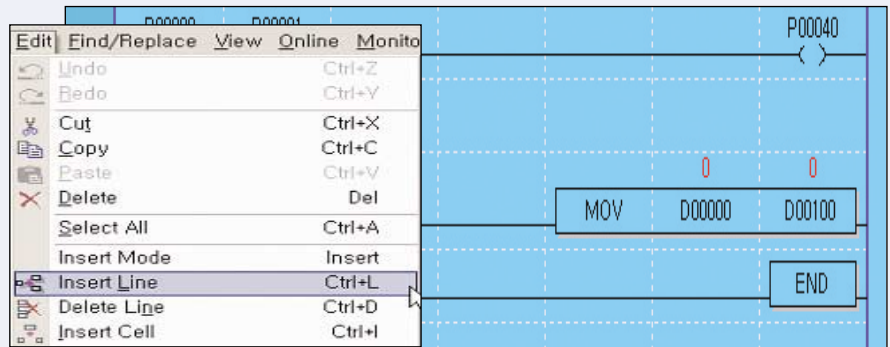

Edit menu

After finishing modifying the program, select [Write Modified Program] and [End Online Editing].

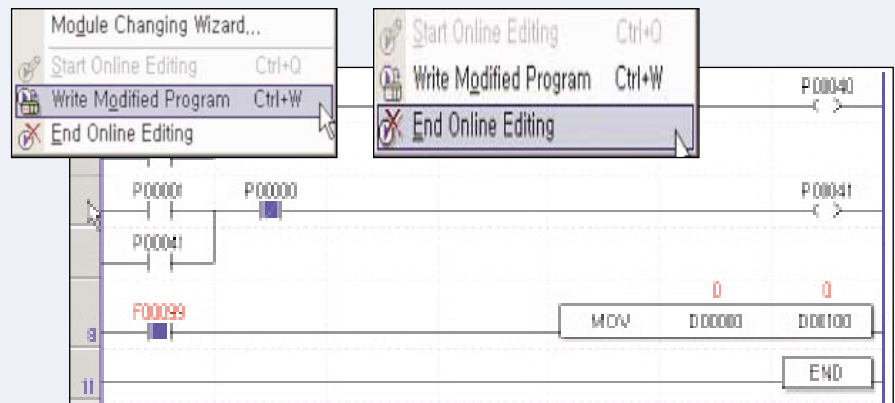

After finishing 'Online Editing'

Open a project written in KGL-WIN

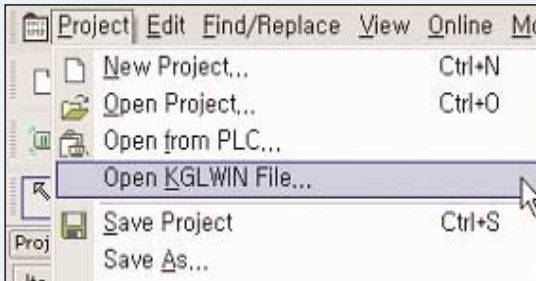

Select [Open KGLWIN file] in project.

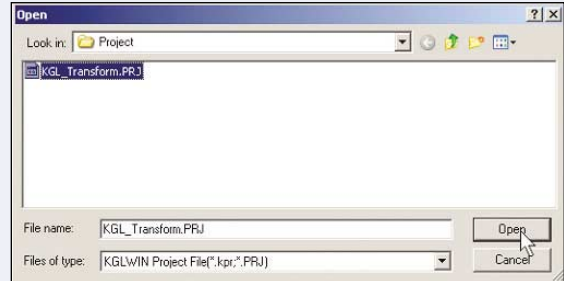

Select the file.

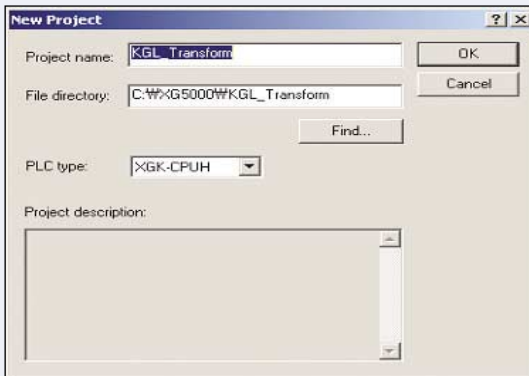

Select the type of XGT CPU.

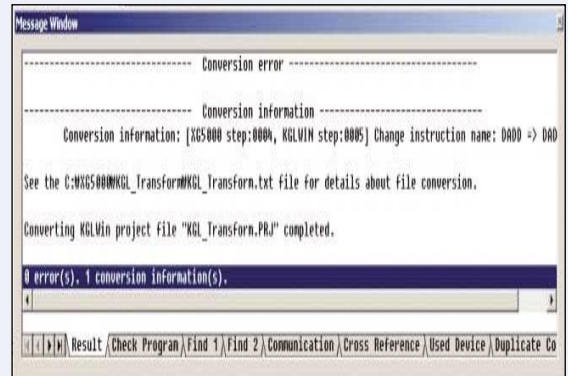

Check converted information in the message window.

Note) Dedicated instructions and special parameters for MASTER-K cannot be converted.
Mostly General instructions and descriptions are converted.
Information impossible to be converted is displayed as ERR.

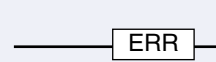

• Content of main special flag (F) change

MASTER-K	XGT	Specifications
F10	F99	ON regularly
F11	F9A	OFF regularly
F12	F9B	ON during first one scan
F13	F9C	OFF during first one scan

For more detailed information, refer to user's manual.

Data type

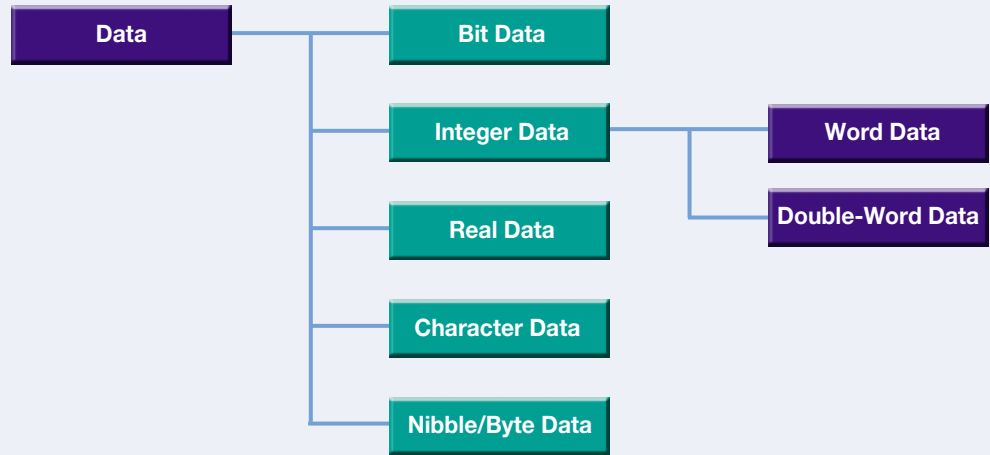

- Nibble: 4-bit unit data
- Byte: 8-bit unit data
- Real Data: 32-bit/64-bit floating point data

Real Number

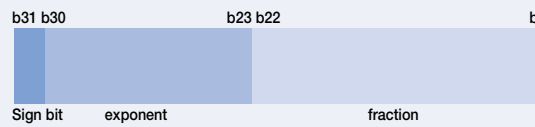

Long Real Number

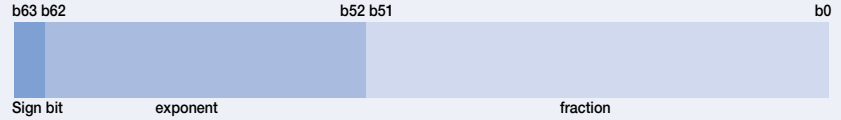

- Character Data: Saving numbers, alphabets, symbols as a type of ASCII code

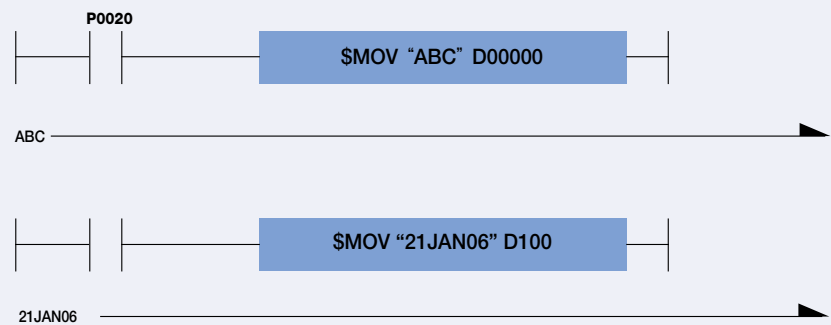

D100	0x31	0x32
D101	0x41	0x4A
D102	0x30	0x4E
D103	0x00	0x36
D104	0x00	0x36

Device Type

Device	Size	Bit Contact	Word Data	Name
P	32768 points	P00000 ~ P2047F	P0000 ~ P2047	I/O Relay
M	32768 points	M00000 ~ M2047F	M0000 ~ M2047	Assistant Relay
L	180224 points	L00000 ~ L11263F	L0000 ~ L11263	Link Relay
N *1)	21K words	N/A	N00000 ~ N21503	Comm. data register
K	32768 points	K00000 ~ K2047F	K0000 ~ K2047	Keep Relay
F	32768 points	F00000 ~ F2047F	F0000 ~ F2047	Special Relay
T *2)	2048 points	T0000 ~ T2047	T0000 ~ T2047	Timer
C *3)	2048 points	C0000 ~ C2047	C0000 ~ C2047	Counter
U	3072 words	U00.00.0 ~ U7F.31.F	U00.00 ~ U7F.31	Special Module Counter
Z	128 words	N/A	Z0 ~ Z127	Index Register
S	128 groups	S00.00 ~ S127.99	N/A	Step Control Relay
D	32K words	D00000.0 ~ D32767.F	D00000 ~ D32767	Data Register
R (Internal RAM) *4)	32K words	R00000.0 ~ R32767.F	R00000 ~ R32767	File Register
ZR (Internal RAM) *5)	32K words	N/A	ZR00000 ~ ZR65535	File Register
R (Expanded)	1M words	N/A	Available as much as extension size	File Register
ZR (Expanded)	1M words	N/A	Available as much as extension size	File Register

Note 1. When communication module is not used, it can be used as internal data area.
 2. Word data in timer shows a current value of relevant bit contact.
 3. Word data in counter shows a current value of relevant bit contact.
 4. Even when using more than 32K words internal RAM, bit contact available to display is R00000.0~R32767.F Also word data enable to be displayed in the range of R00000.0~R32767.F
 5. When internal RAM is more than 32K words, bit contact can be in the range of ZR00000.0~ZR32767.F and word data can be displayed as much as the size of internal RAM

Special module register U

Register for reading data from special module mounted in slot

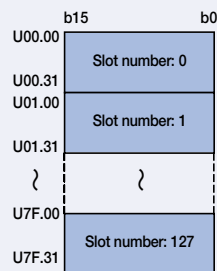

- Assigning 32 words per slot in U area
- Bit type display available
Ex) U93.12.x (x: Bit location, Hexadecimal display)
- Available to read/write internal memory value of special module without using PUT (P), GET (P), PUTS (P), GETS (P)
- Basic display in U area
Ex) Uxy.z
x: Base number (0~7)
y: Slot number (0~F)
z: Word number of special module internal memory

File register R, ZR

Register that a recorded value is not deleted when power failure is occurred. File register is used for data backup or data storage.

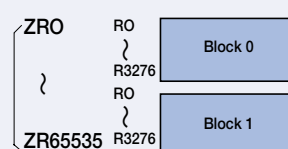

- R: Block unit access
- ZR: Entire file register access
- Internal RAM (Temporary preservation): 32K words
- FLASH (Permanent preservation): 1M words

Index register

Index register sets up devices using index function.
 The sum of index register value and directly specified device number is real device number.

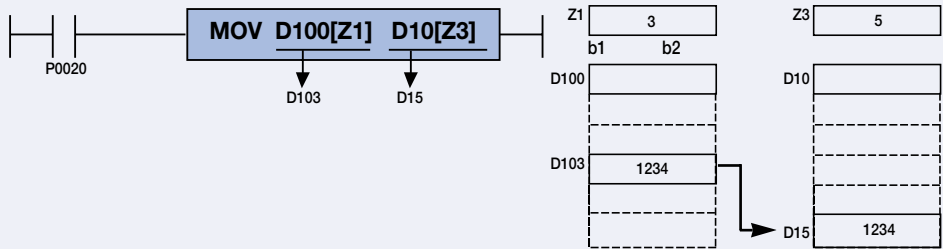

Available Device

- Bit Device: P, M, L, K, F, T, C
 - Word Device: U, D, R, ZR, N, present value of T and present value of C
- Ex) MOV T1[Z1] D10 : If Z1 is 5, present value of T(1+5)=T6 is transmitted to D10.
 Ex) LOAD D10[Z1].5 : If Z1 is 5, LOAD(10+5).5 => LOAD D15.5 is set.

Bit specifying method of word device

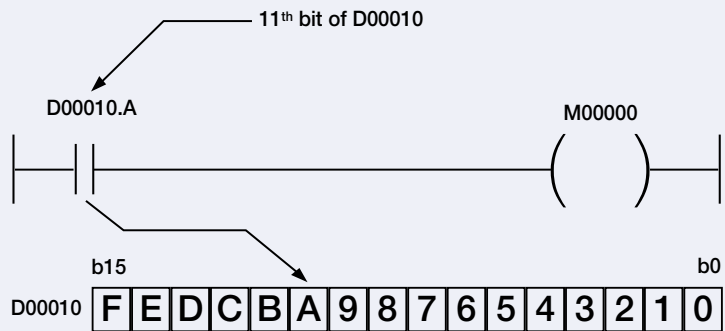

By assigning bit number to word device, bit data is available to use.



In this case, word device number should be addressed as decimal and bit number should be addressed as hexadecimal.

Relevant Device: U, D, R

Instructions

Classification	Designations	Symbol	Description	No. of step
16 Bits transfer	MOV	MOV S D	(S) → (D)	2
	MOVP	MOVP S D	(S) → (D)	3
32 Bits	DMOV	DMOV S D	(S+1 _{ΔS}) → (D+1 _{ΔD})	2
	DMOVP	DMOVP S D	(S+3 _{ΔS} , S+2, S+1, S)	

① **Classification:** Classifies instructions into applications.

② **Designations:** Displays instruction names to be used in program.

- Display rules: Instructions shall be basically displayed in word unit. According to data size, operation characteristics, real number data process, text process, the rules are as follows;
- Based on Data Size & Type
 - D: Double Word related instruction.
 - R: Real Number related instruction.
 - L: Long Real Number related instruction.
 - However, LMOV is 64 Bits transfer instruction.
 - \$: String related instruction.
 - G: Group calculation.
 - 4: Nibble related instruction, used only at the back of instruction.
 - 8: Byte related instruction, used only at the back of instruction.
 - 3: Instruction that process 3 operands, used only at the back of instruction.
- Based on Operation Characteristics
 - P: Instruction that is executed for 1 scan when input signal is changed OFF = > ON

③ **Symbol:** Displays symbols used in program, showing the number of used operands and the type of Source or Destination. Operand display rules are as follows;

- S: Source, with data value not changed after calculated.
- D: Destination, with data value changeable after calculated.
- N, n: The number to process.
- St, En: Start and End, used only in BSFT & WSFT.
- Sb: Source in case Bit position is specified, mostly used in Nibble/Byte instruction.
- Db: Destination in case Bit position is specified.
- Z: Control word, which means previously specified format as based on each instruction.

④ **Description:** Describes general functions of instruction.

⑤ **No. of step:** The number of basic steps of instruction, which means the number of steps in case indirect specification, index formula and direct variable input were not used.

Features

- Convenient user-program, network initial basic setting
- Providing extended monitoring, control function of network system and communication module
- Fast interface with CPU by efficient network management
- Unification of instruction system
- Simple and easy connection using dedicated driver (XGT) and other driver (MODBUS)
- Various built-in Diagnosis functions (Link, Auto-scan, Frame, etc.)



Item		RAPIEnet	FEnet	FDEnet	IFOS FEnet	Cnet	Rnet	DeviceNet	Profibus-DP	
Service	High speed link	○	○	○	○	-	○	○	○	
	XGT server protocol	-	○	-	○	○	-	-	-	
	MODBUS server protocol	-	○	-	○	○	-	-	-	
	P2P	-	○	○	○	○	-	-	-	
	XG5000 Service	○	○	○	○	○	○	-	-	
High speed link	Max. station	64	64	64	64	-	64	64	126/123	
	No. of block	128	128	128	128	-	64	64	126	
	Send block	64	32	32	32	-	32	64	126	
	Receive block	128-Send block				-	32	64	126	
	Data per block	200 words				-	60 words	25 6bytes	244bytes	
P2P	No. of block	-	64	64	64	64	-	-	-	
	Data per block	-	1 st , 2 nd stage connection			256 words	-	-	-	
	Service	-	User defined, XGT client, Modbus client				-	-	-	
System diagnosis		Connection status, network status								
Media		10/100Base-T/FX			100Base-FX	900~115200bps	1Mbps	125/250/500Kbps	9.6K~12Mbps	
Topology		Ring, Bus	Star	Ring, Bus	Star	Bus	Bus	Bus, Star	Bus	
Configuration Tool		XG-PD						XG-PD/SyCon		

Various network diagnosis and monitoring

- Auto Scan: Searching and displaying each node connected to network
- Link Monitor: Monitoring status of high-speed link communication of each station
- Frame Monitor: Collecting and displaying sending/receiving frame in real time



Item	FNet	FDEnet	Cnet	Pnet	Dnet
	Fast Ethernet	Dedicated Ethernet			
Auto Scan	●	●	●	●	●
Link Monitor	●	●	●	●	●
Frame Monitor	—	—	●	—	—

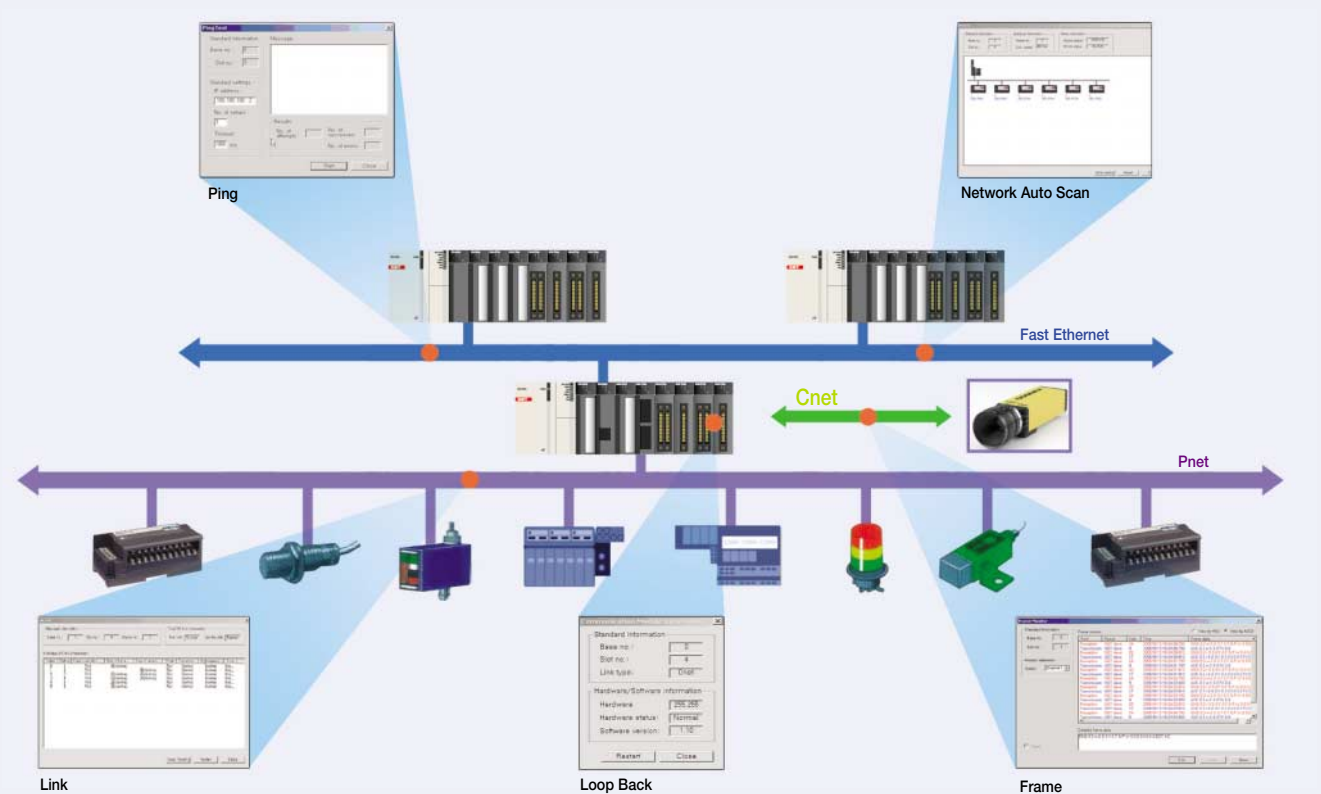

Software

Features

- Windows-based easy operation
- Supporting all types of LS APM module
- Improved parameter editing (Copy, Paste, Initialization, etc.)
- Various monitoring (Operation type of each axis, etc.)
- Profile trace and operation monitoring
- Profile graph and simulation of circular interpolation
- Available to edit operation parameter in EXCEL

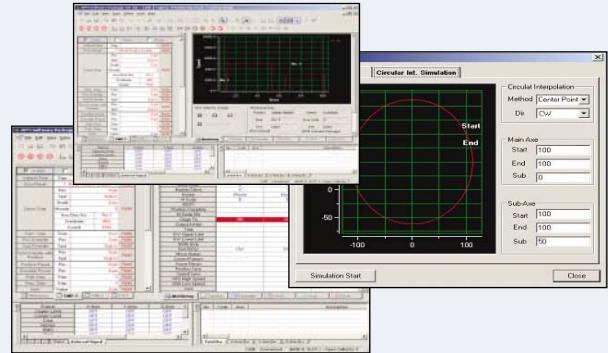

Step	Coord	Control	Pattern	Method	Address [pulse]	Sub-Address [pulse]	M Code	A/D No.	Speed [pulse/s]	Dwell [ms]	Cr/Int Dir
1	ABS	POS	END	SIN	10000	0	0	No.1	1000	0	CW
2	ABS	POS	END	SIN	0	0	0	No.1	0	0	CW
3	ABS	POS	END	SIN	0	0	0	No.1	0	0	CW
4	ABS	POS	END	SIN	0	0	0	No.1	0	0	CW
5	ABS	POS	KEEP	SIN	100000	0	0	No.1	0	0	CW
6	ABS	POS	END	SIN	0	0	0	No.1	10000	0	CW
7	ABS	POS	END	SIN	0	0	0	No.1	10000	0	CW
8	ABS	POS	END	SIN	0	0	0	No.1	0	0	CW
9	ABS	POS	END	SIN	0	0	0	No.1	0	0	CW
10	ABS	POS	CONT	SIN	100000	0	0	No.1	0	0	CW
11	ABS	POS	END	SIN	1000	0	0	No.1	10000	0	CW
12	ABS	POS	END	SIN	0	0	0	No.1	500	0	CW

Operation Data

Define operation method, target location, operation speed of each axis.

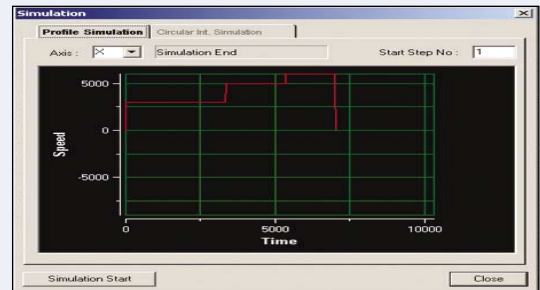

Profile simulation (Off-line)

Monitoring operation speed of each axis with graph type and saving result as image file.

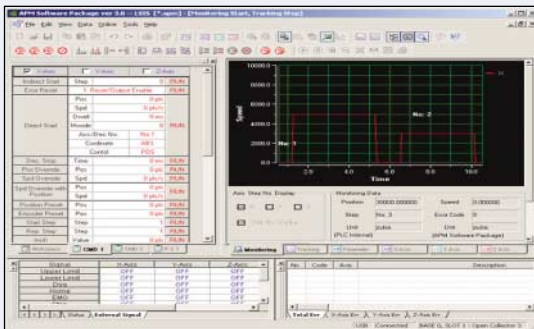

Profile Trace (On-line)

Monitoring operation speed of each axis with graph type and saving result as image file.

Axis	0 Axis	1 Axis	2 Axis	3 Axis
Max. Pos. Limit	0.00000 [mm]	0.00000 [mm]	0.00000 [mm]	0.00000 [mm]
Min. Pos. Limit	0.00000 [mm]	0.00000 [mm]	0.00000 [mm]	0.00000 [mm]
Max. Vel. Limit	0.00000 [mm/s]	0.00000 [mm/s]	0.00000 [mm/s]	0.00000 [mm/s]
Max. Acc. Limit	0.00000 [mm/s²]	0.00000 [mm/s²]	0.00000 [mm/s²]	0.00000 [mm/s²]
Max. Dec. Limit	0.00000 [mm/s²]	0.00000 [mm/s²]	0.00000 [mm/s²]	0.00000 [mm/s²]
Max. Jerk Limit	0.00000 [mm/s³]	0.00000 [mm/s³]	0.00000 [mm/s³]	0.00000 [mm/s³]
Max. Feed Rate	0.00000 [mm/min]	0.00000 [mm/min]	0.00000 [mm/min]	0.00000 [mm/min]
Max. Rapid Rate	0.00000 [mm/min]	0.00000 [mm/min]	0.00000 [mm/min]	0.00000 [mm/min]
Max. Traverse Rate	0.00000 [mm/min]	0.00000 [mm/min]	0.00000 [mm/min]	0.00000 [mm/min]
Max. Retract Rate	0.00000 [mm/min]	0.00000 [mm/min]	0.00000 [mm/min]	0.00000 [mm/min]
Max. Approach Rate	0.00000 [mm/min]	0.00000 [mm/min]	0.00000 [mm/min]	0.00000 [mm/min]
Max. Withdraw Rate	0.00000 [mm/min]	0.00000 [mm/min]	0.00000 [mm/min]	0.00000 [mm/min]
Max. Feed Rate (Circular)	0.00000 [mm/min]	0.00000 [mm/min]	0.00000 [mm/min]	0.00000 [mm/min]
Max. Rapid Rate (Circular)	0.00000 [mm/min]	0.00000 [mm/min]	0.00000 [mm/min]	0.00000 [mm/min]
Max. Traverse Rate (Circular)	0.00000 [mm/min]	0.00000 [mm/min]	0.00000 [mm/min]	0.00000 [mm/min]
Max. Retract Rate (Circular)	0.00000 [mm/min]	0.00000 [mm/min]	0.00000 [mm/min]	0.00000 [mm/min]
Max. Approach Rate (Circular)	0.00000 [mm/min]	0.00000 [mm/min]	0.00000 [mm/min]	0.00000 [mm/min]
Max. Withdraw Rate (Circular)	0.00000 [mm/min]	0.00000 [mm/min]	0.00000 [mm/min]	0.00000 [mm/min]
Max. Feed Rate (Linear)	0.00000 [mm/min]	0.00000 [mm/min]	0.00000 [mm/min]	0.00000 [mm/min]
Max. Rapid Rate (Linear)	0.00000 [mm/min]	0.00000 [mm/min]	0.00000 [mm/min]	0.00000 [mm/min]
Max. Traverse Rate (Linear)	0.00000 [mm/min]	0.00000 [mm/min]	0.00000 [mm/min]	0.00000 [mm/min]
Max. Retract Rate (Linear)	0.00000 [mm/min]	0.00000 [mm/min]	0.00000 [mm/min]	0.00000 [mm/min]
Max. Approach Rate (Linear)	0.00000 [mm/min]	0.00000 [mm/min]	0.00000 [mm/min]	0.00000 [mm/min]
Max. Withdraw Rate (Linear)	0.00000 [mm/min]	0.00000 [mm/min]	0.00000 [mm/min]	0.00000 [mm/min]

Operation parameter

Setting basic operation characteristics and limit value.

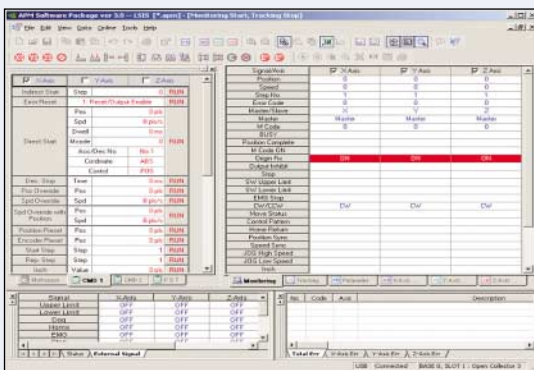

Monitoring (On-line)

Checking basic operation characteristics about each axis and monitoring operation condition.

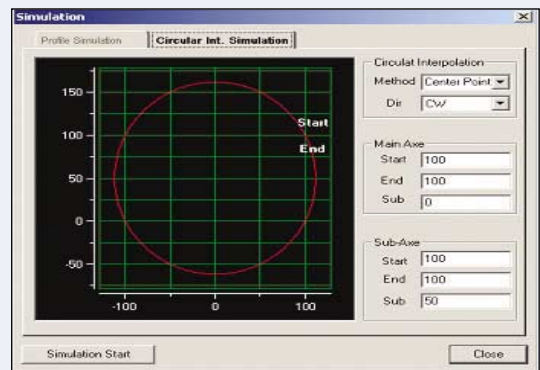

Circular interpolation simulation (Off-line)

Product list

CPU / PWR / Base / I/O		
CPU	XGI-CPUU	6,144pt (IEC type), Program memory: 1Mbyte
	XGI-CPUH	6,144pt (IEC type), Program memory:1.5Mbyte
	XGK-CPUU	6,144pt, Program memory : 128Ksteps
	XGK-CPUH	6,144pt, Program memory : 64Ksteps
	XGK-CPUA	3,072pt, Program memory : 32Ksteps
	XGK-CPUS	3,072pt, Program memory : 32Ksteps
	XGK-CPUE	1,536pt, Program memory : 16Ksteps
Power	XGP-ACF1	Free Voltage/DC5V 3A, DC24V 0.6A
	XGP-ACF2	Free Voltage/DC5V 6A
	XGP-AC23	220V/DC5V 8.5A
	XGP-DC42	DC24V/DC5V 6A
Main base	XGB-M04A	4 Slot
	XGB-M06A	6 Slot
	XGB-M08A	8 Slot
	XGB-M12A	12 Slot
Expansion base	XGB-E04A	4 Slot
	XGB-E06A	6 Slot
	XGB-E08A	8 Slot
	XGB-E12A	12 Slot
Input	XGI-A12A	AC110V, 16pt
	XGI-A21A	AC220V, 8pt
	XGI-D21A	DC24V, 8pt
	XGI-D22A	DC24V, 16pt, Sink/Source
	XGI-D22B	DC24V, 16pt, Source
	XGI-D24A	DC24V, 32pt, Sink/Source
	XGI-D24B	DC24V, 32pt, Source
	XGI-D28A	DC24V, 64pt, Sink/Source
	XGI-D28B	DC24V, 64pt, Source
Output	XGQ-RY1A	Relay, 8pt
	XGQ-RY2A	Relay, 16pt
	XGQ-RY2B	Relay, 16pt, Surge killer
	XGQ-SS2A	Triac, 16pt
	XGQ-TR2A	Transist, 16pt, Sink
	XGQ-TR2B	Transist, 16pt, Source
	XGQ-TR4A	Transist, 32pt, Sink
	XGQ-TR4B	Transist, 32pt, Source
	XGQ-TR8A	Transist, 64pt, Sink
	XGQ-TR8B	Transist, 64pt, Source
Input/output	XGH-DT4A	DC24V 16pt, Transist, 16pt, Sink

Communication module		
RAPIenet	XGL-EIMT	RAPIenet Twisted pair
	XGL-EIMH	RAPIenet Twisted pair/ Fiber
	XGL-EIMF	RAPIenet Fiber optic 2ch
	XOL-EIMT	RAPIenet Twisted pair 2ch
	XOL-EIMF	RAPIenet Fiber optic 2ch (PC)
Cnet	XGL-CH2A	RS-232C/RS-422
	XGL-C22A	RS-232C, 2ch
	XGL-C42A	RS-422, 2ch
Ethernet	XGL-EFMF	Fiber optic, Open type
	XGL-EFMT	Twisted pair, Open
	XGL-ESHF	Fast Ethernet type (Industrial optic ring)
	XGL-EHST	Fast Ethernet switch hub
Dedicated	XGL-EDMF	Fiber optic, Dedicated
	XGL-EDMT	Ethernet Twisted pair, Dedicated Ethernet
Rnet	XGL-RMEA	Rnet, Master
Dnet	XGL-DMEA	DeviceNet, Master
Pnet	XGL-PMEA	Profibus-DP, Master
	XGL-PMEC	

Special module		
Analog input	XGF-AV8A	Voltage, 8ch
	XGF-AC8A	Current, 8ch
	XGF-AD8A	Voltage /Current, 8ch
	XGF-AD4S	Voltage /Current, 4ch,
	XGF-AD16A	Insulation Voltage /Current, 16ch
Analog output	XGF-DV4A	Voltage, 4ch
	XGF-DC4A	Current, 4ch
	XGF-DV8A	Voltage, 8ch
	XGF-DC8A	Current, 8ch
	XGF-DV4S	Voltage, 4ch, Insulation
High speed counter	XGF-DC4S	Current, 4ch, Insulation
	XGF-HO2A	Open collector, 2ch
	XGF-HD2A	Line drive, 2ch
Positioning	XGF-PO3A	Open collector, 3axes
	XGF-PO2A	Open collector, 2axes
	XGF-PO1A	Open collector, 1axis
	XGF-PD3A	Line drive, 3axes
	XGF-PD2A	Line drive, 2axes
	XGF-PD1A	Line drive, 1axis
Temperature input	XGF-TC4S	Thermo couple, 4ch, Insulation
	XGF-RD4A	RTD, 4ch
	XGF-RD4S	RTD, 4ch, Insulation
Temperature controller	XGF-TC4UD	4 loops, Insulation

Cable		
Item	Product	Description
Expansion cable	XGC-E041	0.4m
	XGC-E061	0.6m
	XGC-E121	1.2m
	XGC-E301	3.0m
	XGC-E501	5.0m
	XGC-E102	10m
	XGC-E152	15m
Termination connector	XGT-TERA	Termination connector for expansion base download cable
USB cable	USB-301A	USB download cable
RS232C cable	K1C-050A	RS232C download cable
Dummy	XGT-DMMA	Dummy module

XGR module		
CPU	XGR-CPUH/T	Twisted pair
	XGR-CPUH/F	Fiber optic
Power	XGR-AC12	110V, 5.5A(Main base)
	XGR-AC13	110V, 8.5A(Expansion base)
	XGR-AC22	220V, 5.5A(Main base)
	XGR-AC23	220V, 8.5A(Expansion base)
Base	XGR-M06P	6Slot(Main base)
	XGR-E12P	12Slot(Expansion base)
Expansion drive	XGR-DBST	Twisted pair - Twisted
	XGR-DBSF	pair Fiber optic - Fiber optic
	XGR-DBSH	Twisted pair - Fiber optic
Sync & Expansion cable	XGC-F201	2m (Fiber optic)
	XGC-F501	5m (Fiber optic)

Dimensions

• Base

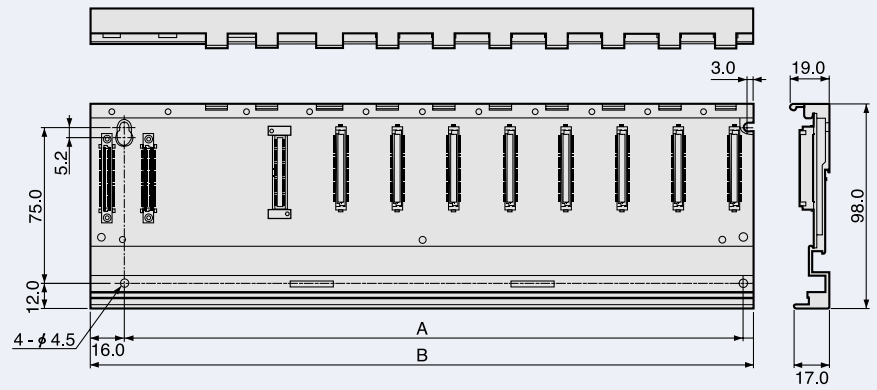

• Power module

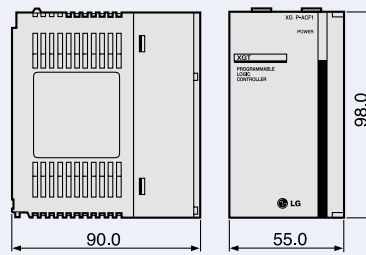

• CPU and I/O module

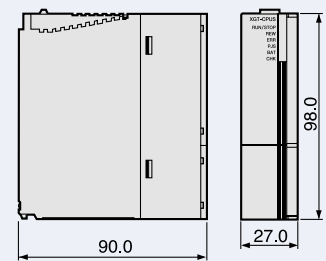

Base Dimensions (W)

Item	XGB-M04A/E04A	XGB-M06A/E06A	XGB-M08A/E08A	XGB-M12A/E12A
A	190	244	298	406
B	210	264	318	426

XGR Dimensions

Dimensions

• Base base

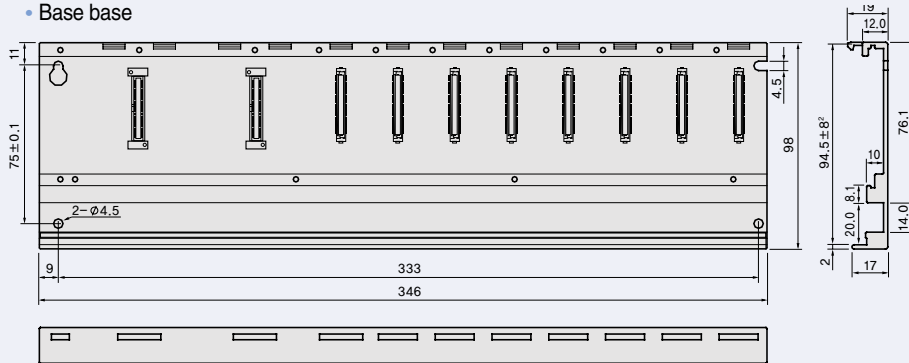

• Expansion base

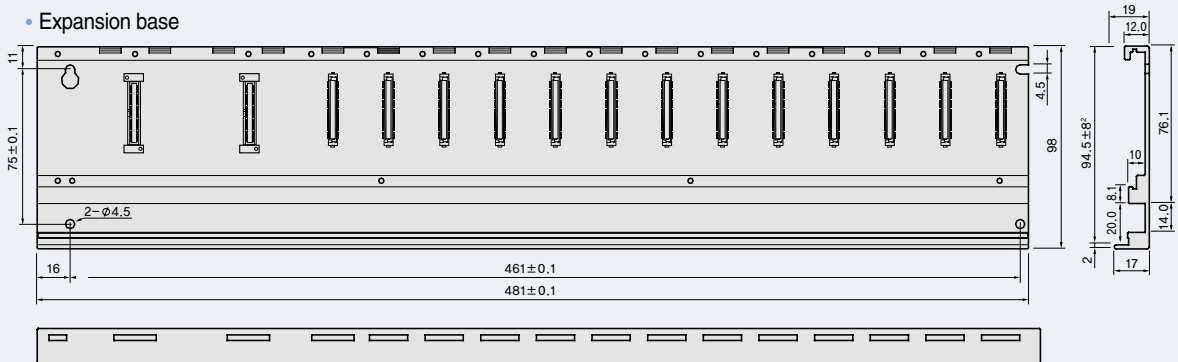

• Power and CPU

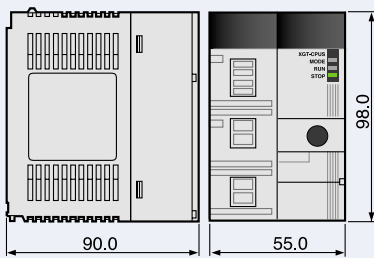

• I/O

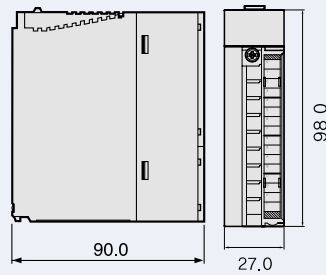

Base Dimensions (W)

Item	XGR-M06P	XGR-E12P
A	333	461
B	346	481



Memo

A large, empty rectangular area with a light blue background and a thin blue border, intended for writing a memo.

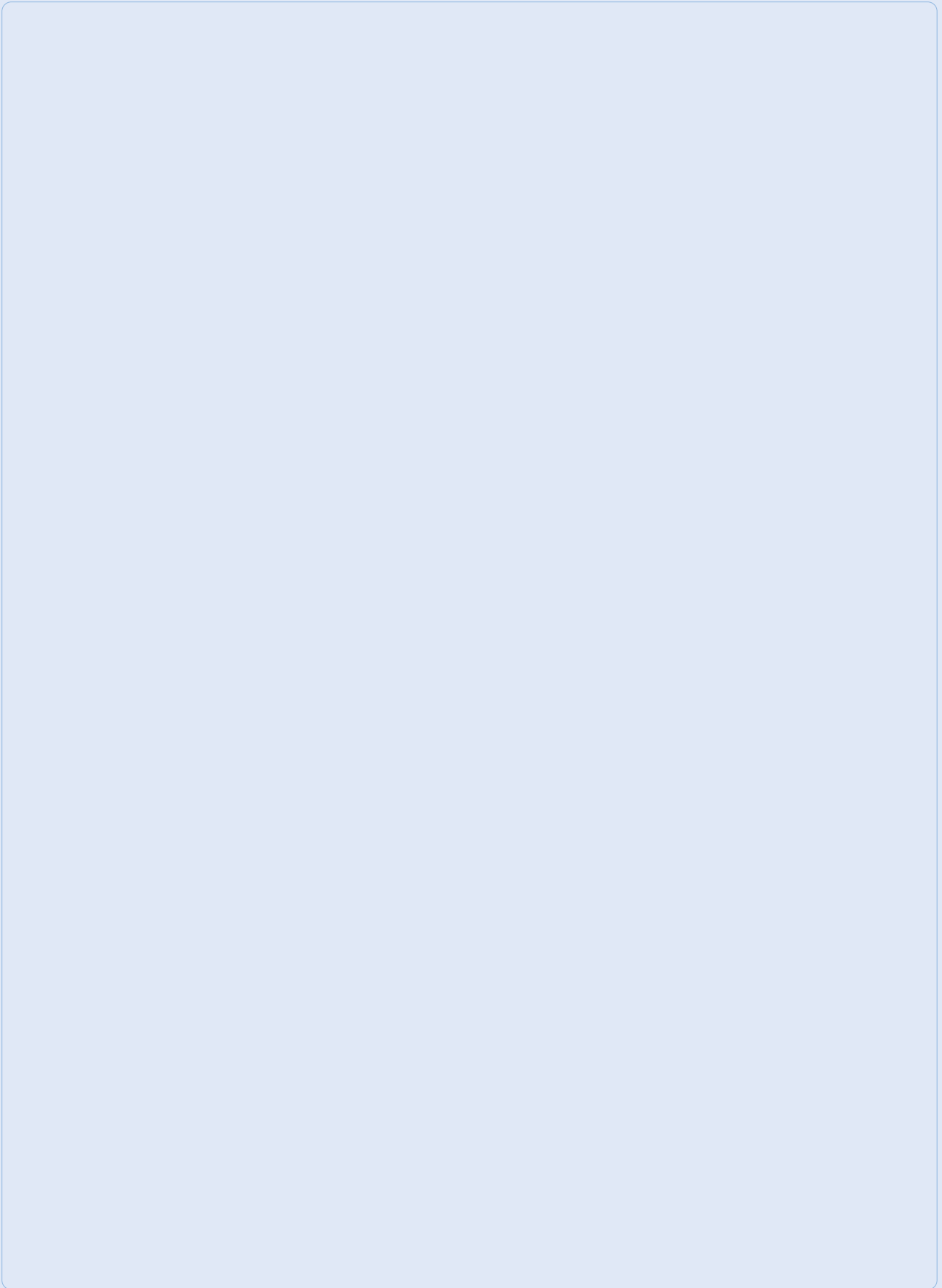



Safety Instructions

- For your safety, please read user's manual thoroughly before operating.
- Contact the nearest authorized service facility for examination, repair, or adjustment.
- Please contact qualified service technician when you need maintenance.
Do not disassemble or repair by yourself!
- Any maintenance and inspection shall be performed by the personnel having expertise concerned.

2005.11 LS Industrial Systems Co.,Ltd. All rights reserved.

LS Industrial Systems Co., Ltd.

www.lsis.biz

HEAD OFFICE

LS Tower, 1026-6 Hokyeh 1dong, Dongan-gu, Anyang,
Kyonggi-Do, 431-848, Korea

Tel. (82-2)2034-4888

Fax. (82-2)2034-4648

Global Network

- **LS Industrial Systems (Middle East) FZE Dubai, U.A.E.**
Address: P.O.Box-114216, API World Tower, 303B, Sheikh Zayed Road, Dubai, U.A.E.
Tel: 971-4-886 5360 Fax: 971-4-886-5361 e-mail: hwym@lsis.biz
- **Dalian LS Industrial Systems Co., Ltd. Dalian, China**
Address: No.15, Liaohexi 3-Road, Economic and Technical Development zone, Dalian 116600, China
Tel: 86-411-8273-7777 Fax: 86-411-8730-7560 e-mail: lixx@lsis.com.cn
- **LS Industrial Systems (Wuxi) Co., Ltd. Wuxi, China**
Address: 102-A, National High & New Tech Industrial Development Area, Wuxi, Jiangsu,214028, P.R.China
Tel: 86-510-8534-6666 Fax: 86-510-522-4078 e-mail: xuhg@lsis.com.cn
- **LS-VINA Industrial Systems Co., Ltd. Hanoi, Vietnam**
Address: Nguyen Khe - Dong Anh - Ha Noi - Viet Nam
Tel: 84-4-882-0222 Fax: 84-4-882-0220 e-mail: srjo@lsisvina.com
- **LS-VINA Industrial Systems Co., Ltd. Hochiminh, Vietnam**
Address: 41 Nguyen Thi Minh Khai Str. Yoco Bldg 4th Floor, Hochiminh City, Vietnam
Tel: 84-8-3822-7941 Fax: 84-8-3822-7942 e-mail: sbpark@lsisvina.com
- **LS Industrial Systems Tokyo Office Tokyo, Japan**
Address: 16FL, Higashi-Kan, Akasaka Twin Tower 17-22, 2-chome, Akasaka, Minato-ku Tokyo 107-8470, Japan
Tel: 81-3-3582-9128 Fax: 81-3-3582-2667 e-mail: jschuna@lsis.biz
- **LS Industrial Systems Shanghai Office Shanghai, China**
Address: Room E-G, 12th Floor Huamin Empire Plaza, No.726, West Yan'an Road Shanghai 200050, P.R. China
Tel: 86-21-5237-9977 (609) Fax: 89-21-5237-7191 e-mail: jinhk@lsis.com.cn
- **LS Industrial Systems Beijing Office Beijing, China**
Address: B-Tower 17FL,Beijing Global Trade Center B/D. No.36, BeiSanHuanDong-Lu, DongCheng-District, Beijing 100013, P.R. China
Tel: 86-10-5825-6025,7 Fax: 86-10-5825-6026 e-mail: cuixiaorong@lsis.com.cn
- **LS Industrial Systems Guangzhou Office Guangzhou, China**
Address: Room 1403,14F,New Poly Tower,2 Zhongshan Liu Road,Guangzhou, P.R. China
Tel: 86-20-8326-6764 Fax: 86-20-8326-6287 e-mail: linsz@lsis.biz
- **LS Industrial Systems Chengdu Office Chengdu, China**
Address: 12Floor, Guodong Building, No52 Jindun Road Chengdu, 610041, P.R. China
Tel: 86-28-8612-9151 Fax: 86-28-8612-9236 e-mail: yangcf@lsis.com.cn
- **LS Industrial Systems Qingdao Office Qingdao, China**
Address: 7B40,Haixin Guangchang Sheny Building B, No.9, Shandong Road Qingdao 26600, P.R. China
Tel: 86-532-8501-6568 Fax: 86-532-583-3793 e-mail: lirj@lsis.com.cn



Specifications in this catalog are subject to change without notice due to continuous product development and improvement.